



Energy efficiency -  
thinking ahead



The first part of the document discusses the importance of maintaining accurate records of all transactions. It emphasizes that every entry, no matter how small, should be recorded to ensure the integrity of the financial data. This includes not only sales and purchases but also expenses and income. The document provides a detailed list of items that should be tracked, such as inventory levels, accounts payable, and accounts receivable. It also outlines the procedures for recording these transactions, including the use of double-entry bookkeeping to ensure that the books are balanced.

The second part of the document focuses on the analysis of the financial data. It explains how to calculate key financial ratios and metrics, such as the gross profit margin, operating profit margin, and return on investment. These metrics are used to evaluate the company's performance and identify areas for improvement. The document also discusses the importance of comparing the company's performance to industry benchmarks and competitors.

The third part of the document covers the preparation of financial statements. It provides a step-by-step guide to creating the income statement, balance sheet, and cash flow statement. It also explains how to interpret these statements and what they tell you about the company's financial health. The document includes sample financial statements and explains how to use them to make informed business decisions.

Finally, the document discusses the importance of financial planning and budgeting. It explains how to create a budget and how to use it to track the company's performance against its goals. It also discusses the importance of reviewing the budget regularly and making adjustments as needed. The document concludes by emphasizing the importance of maintaining accurate financial records and using the data to make informed business decisions.

# ETA - the model factory

---

Energy efficiency - thinking ahead



**Authors:**

Prof. Eberhard Abele  
 Prof. Jens Schneider  
 Martin Beck  
 Andreas Maier

**The ETA Factory – a model factory for system-oriented concepts**

In the industry, the topic of energy efficiency will continue to gain in importance because companies and commercial enterprises must, on the one hand, take on the responsibility to contribute to climate protection, and, on the other hand, they are economically forced to minimise production cost. Conscious and sustainable handling of the precious resource energy concerns all economic sectors of our society. They must be seen as one single system - today more than ever before. Against this background, any engineer should base his or her work on the principle of developing (energy) efficient processes and production operations that are sustainable and environmentally friendly.

In 2011, the 6<sup>th</sup> energy research programme was initiated, focussing on the goals of the energy transition. The goal of the energy transition initiative is to ensure sustainable and safe energy supply while keeping it economically viable. The programme focusses on a system-oriented research approach, and the ETA Factory represents this approach in an exemplary manner.

The concept drives at coupling inter-technological and interdisciplinary solutions to increase the energy efficiency of the overall system. The ETA Factory is a large demonstrator of excellent individual and compound solutions of the different engineering disciplines. An interdisciplinary team from mechanical engineering to civil engineering and architecture, from electrical engineering and building services engineering to communication technology, has identified outstanding innovations, realised them in practise, and demonstrated them in the context of an industrial process chain and a building envelope.

The ETA Factory and the team of TU Darmstadt call attention to the possibilities of energy efficiency in the industry by means of lectures, university courses and continuing education classes as well as many scientific publications, individually and in the university context. Around 1,500 visitors per year show their interest in the technological innovations presented, as they present a significant impulse for production operations as well as the building sector to achieve the goals set for the energy transition. The mutually developed ideas strengthen the knowledge transfer between research and industry, simultaneously advance the knowledge gain of our students, and motivate young scientists to found their own enterprises.

The ETA Factory shows that a system-oriented approach is worthwhile. And that we must invest more in the technologies and education aimed at increasing energy efficiency. This brochure provides a concise summary of the research results – a specialised book is in the planning, which shall reflect and conclude this special research project. ■

01 With its integrative approach to create the world-first prototype, the ETA Factory project strives toward a new developmental era for the energetically optimised production facility of the future. Andreas Maier, Prof. Jens Schneider, Prof. Eberhard Abele, and Martin Beck (from left to right) posing in front of the ETA Factory in their dual role as project leaders and editors of this brochure.

© 2018

All rights reserved.

Publishers: Prof. Eberhard Abele, Prof. Jens Schneider,  
Martin Beck, Andreas Maier  
Editorial: Claudia Siegele, Karlsruhe ([www.frei04-publizistik.de](http://www.frei04-publizistik.de))  
Design: Björn Maser, Stuttgart ([www.minimalist.cn](http://www.minimalist.cn))  
Graphics: Sandra Antes and Emily Broschk (PTW, TU Darmstadt)  
Translation: Usch Engelmann ([www.uschengelmann.com](http://www.uschengelmann.com))  
Repro and production: Elke Weber, Stuttgart ([www.ctrl-s.de](http://www.ctrl-s.de))  
Print: Henkel GmbH Druckerei, Stuttgart ([www.henkeldruck.de](http://www.henkeldruck.de))  
Paper: Munken Lynx  
Printed in Germany  
ISBN 978-3-00-059397-0

Gefördert durch:



Overseen by:



Supported by:



aufgrund eines Beschlusses  
des Deutschen Bundestages

A project of:



Picture credits:

Page 2 Fig. 01, PTW Sibylle Scheibner; Page 6 Fig. 01, HA Hessen Agentur GmbH - Jan Michael Hosan;  
Page 7 Fig. 01, Eibe Sönnecken; Page 7 Fig. 02, HA Hessen Agentur GmbH - Jan Michael Hosan; Page 7  
Fig. 03, Eibe Sönnecken; Page 9 Fig. 01, DJA Architekten, Frankfurt; Page 10 Fig. 02, DJA Architekten,  
Frankfurt; Page 11 Fig. 03, Prof. Eisele and Dr.-Ing. Frank Lang, formerly 'Entwerfen und  
Baugestaltung' (EuB), Faculty of Architecture, TU Darmstadt; Page 12 Fig. 01, HA Hessen Agentur  
GmbH - Jan Michael Hosan; Page 12 Fig. 02, PTW; Page 13 Fig. 03, EMAG Salach Maschinenfabrik  
GmbH / PTW; Page 14 Fig. 04, PTW; Page 15 Fig. 05, PTW; Page 15 Fig. 06, Jan Michael Hosan; Page 16  
Fig. 07, PTW, Diss, Tilo Sielaff. Zum Einsatz von Synchronreluktanzmotoren in Motorspindeln für  
Universal-Bearbeitungszentren, Shaker-Verlag, July 2017, ISBN: 978-3-8440-5343-2 (MW); Page 16  
Fig. 08, HA Hessen Agentur GmbH - Jan Michael Hosan; Page 17 Fig. 09, PTW; Page 17 Fig. 10, Jan  
Michael Hosan; Page 17 Fig. 11, Jan Michael Hosan; Page 18 Fig. 12, MAFAC - E. Schwarz & Co. KG /  
PTW; Page 18 Fig. 13, ZAE-Bayern / HA Hessen Agentur GmbH - Jan Michael Hosan; Page 19 Fig. 14,  
Jan Michael Hosan; Page 20 Fig. 15, IWT Bremen; Page 21 Fig. 16, Jan Michael Hosan; Page 22 Fig. 17,  
Jan Michael Hosan; Page 22 Fig. 18, Jan Michael Hosan; Page 23 Fig. 19, PTW; Page 23 Fig. 20, Jan  
Michael Hosan; Page 24 Fig. 01, PTW; Page 25 Fig. 02, PTW; Page 25 Fig. 03, HA Hessen Agentur  
GmbH - Jan Michael Hosan; Page 26 Fig. 04, PTW / Eibe Sönnecken; Page 27 Fig. 05, PTW; Page 27  
Fig. 06, MAFAC - E. Schwarz & Co. KG / PTW; Page 28 Fig. 07, HA Hessen Agentur GmbH - Jan Michael  
Hosan; Page 28 Fig. 08, PTW; Page 29 Fig. 09, PTW; Page 29 Fig. 10, Jan Michael Hosan; Page 30 Fig.  
11, Jan Michael Hosan; Page 31 Fig. 12, PTW; Page 32 Fig. 13, PTW; Page 33 Fig. 14, Jan Michael Hosan;  
Page 34 Fig. 15, PTW; Page 35 Fig. 16, PTW; Page 36 Fig. 17, IMS; Page 36 Fig. 18, IMS; Page 37 Fig. 19,  
IMS; Page 38 Fig. 01, ISM+D / WiB; Page 39 Fig. 02, Eibe Sönnecken; Page 39 Fig. 03, ISM+D; Page 40  
Fig. 04, ISM+D / WiB; Page 40 Fig. 05, ISM+D; Page 41 Fig. 06, Eibe Sönnecken; Page 41 Fig. 07, DJA  
Architekten, Frankfurt; Page 42 Fig. 08, Alexander Wien; Page 42 Fig. 09, Alexander Wien; Page 43  
Fig. 10, Eibe Sönnecken; Page 43 Fig. 11, Eibe Sönnecken; Page 44 Fig. 12, Eibe Sönnecken; Page 44  
Fig. 13, Eibe Sönnecken; Page 45 Fig. 14, Eibe Sönnecken; Page 45 Fig. 15, Eibe Sönnecken; Page 46  
Fig. 16, DJA Architekten, Frankfurt; Page 46 Fig. 17, DJA Architekten, Frankfurt; Page 46 Fig. 18, DJA  
Architekten, Frankfurt; Page 47 Fig. 19, SINNBILD, Darmstadt; Page 47 Fig. 20, Eibe Sönnecken; Page  
47 Fig. 21, Eibe Sönnecken; Page 48 Fig. 22, Eibe Sönnecken; Page 48 Fig. 23, ISM+D; Page 49 Fig. 24,  
Eibe Sönnecken; Page 49 Fig. 25, Eibe Sönnecken; Page 50 Fig. 01, Jan Michael Hosan; Page 51 Fig. 02,  
PTW; Page 52 Fig. 03, PTW; Page 53 Fig. 04, Jan Michael Hosan; Page 53 Fig. 05, ISM+D; Page 54 Fig.  
06, PTW; Page 55 Fig. 07, PTW; Page 56 Fig. 08, Eibe Sönnecken; Page 58 Fig. 01, Eibe Sönnecken;  
Page 59 Fig. 02, PTW, HA Hessen Agentur GmbH - Jan Michael Hosan, Eibe Sönnecken; Page 60 Fig.  
01, PTW; Page 60 Fig. 02, PTW; Page 61 Fig. 03, Jan Michael Hosan; Page 62 Fig. 04, PTW

# Content

Preface . . . . .	3
1.0 From theory to concept . . . . .	8
1.1 Onset and background . . . . .	8
1.2 Innovations – guiding principle and concept . . . . .	11
2.0 Production process chain . . . . .	12
2.1 Energy efficient machine cutting with machine tools . . . . .	13
2.2 Energy efficient component cleaning . . . . .	16
2.3 Energy efficient heat treatment . . . . .	19
3.0 Energetic networks . . . . .	24
3.1 Thermal energy networks . . . . .	24
3.2 Energy data on the ETA Factory . . . . .	30
3.3 Energy flow control in the ETA Factory . . . . .	34
3.4 Kinetic energy storage . . . . .	36
4.0 Innovative shell, efficient core . . . . .	38
4.1 The energy optimised building envelope as part of the process chain . . . . .	38
4.2 Energetic integration of ventilation ceilings and glass facades into the ETA Factory . . . . .	42
4.3 Design . . . . .	45
5.0 The virtual, energy efficient factory . . . . .	50
5.1 Information gain through simulation . . . . .	51
5.2 From component to factory system . . . . .	52
ETA Forum . . . . .	59
Theory and practice under one roof . . . . .	59
Factsheet . . . . .	60







# ETA – the future factory

Three disciplines – one idea



# 1.0 From theory to concept

## 1.1 Onset and background

Energy efficiency in the production technological environment requires a close collaboration between engineers from various disciplines. Just like the building sector, mechanical engineering must focus on efficiency. While discussing the question of how the efficiency of a machine cutting machine could be optimised, the idea came up to work together in a team of architects and civil engineers who should not limit their energetic considerations to either the production facility or to the machines of a production process chain, respectively, but to rather comprehend the production facility holistically in the sense of a “machine around the machine”. This theoretic approach opens up numerous new scientific questions:

- On a machine level, how can we achieve improved efficiency by avoiding waste heat whenever possible, and efficiently dissipate waste heat that is unavoidable?
- How can we exploit waste heat in the framework of a thermal crosslinking system, and how can we integrate electric energy storage to influence the load curve?
- In what way can thermally activated areas of the building envelope contribute to cooling and heating the building, as well as supply cooling water either as a supportive measure or as the predominant source?
- What possibilities does digitalisation offer in terms of increasing efficiency in practice, optimally controlling energy flows, and planning production facilities more efficiently?

An interdisciplinary collaboration developed during the course of the project. Led by Prof. Abele (PTW), a team of members from research institutes of Civil Engineering, Prof. Jens Schneider (ISM+D) und Prof. Harald Garrecht (formerly WiB TU Darmstadt), and Architecture, Prof. Johann Eisele (formerly EuB), developed an integral concept of a production facility which corresponds to and is interconnected with the production-technical processes taking place inside it. The complex task to integrate each and every participant in the process lay with Martin Beck, who synergistically merged the individual disciplines.

The project execution organisation Jülich (Ptj) and, thus, the Federal Ministry for Economic Affairs and Energy (BMWi) were involved in the project from a very early concept phase onward.

### Authors:

Prof. Eberhard Abele  
PTW, TU Darmstadt

Prof. Jens Schneider  
ISM+D, TU Darmstadt

Martin Beck  
PTW, TU Darmstadt

Andreas Maier  
ISM+D, TU Darmstadt

01 Cross-section and view of the south façade with the parametric glass elements

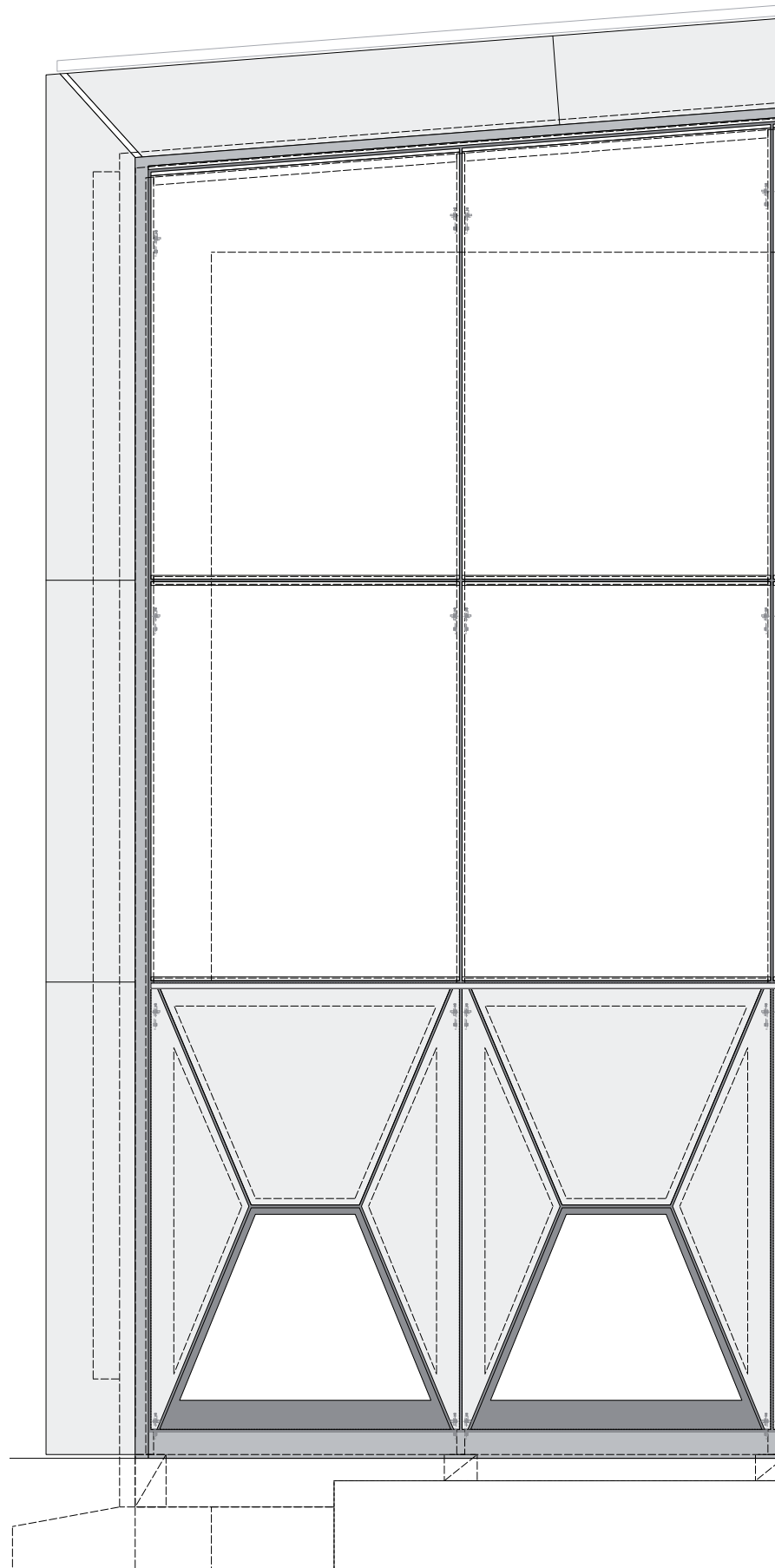

The first industry partner that signed up for the project was Bosch Rexroth AG. Soon, in the beginning of 2011, the participation of various partners from the industry and academia allowed for the establishment of a consortium consisting of 13 project partners. The ETA Factory was born. Machine and system related realisation was then led by PTW, while ISM+D, Department V of TU Darmstadt and Dietz-Joppien Architekten, Frankfurt, were responsible for the building construction part of the project.

Thus, the research into the 'large equipment' ETA Factory stands for energetic system optimisation by shifting the system boundaries between machines and building. This approach was used to show marketable, economically viable energy savings potentials of approximately 40 percent compared to a conventional production facility.

02 Assembly process of the production hall, from pouring the concrete foundation to completion

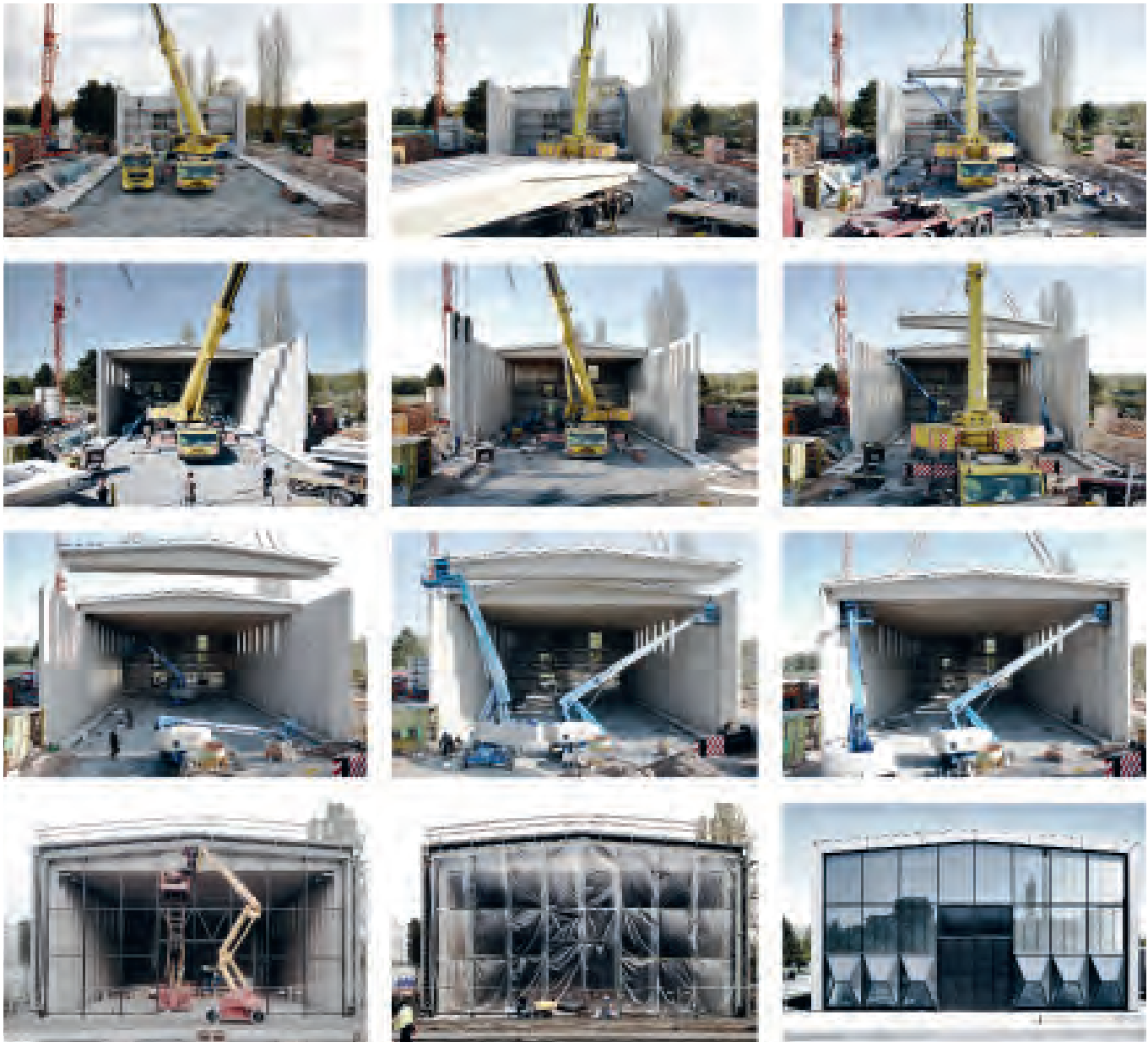

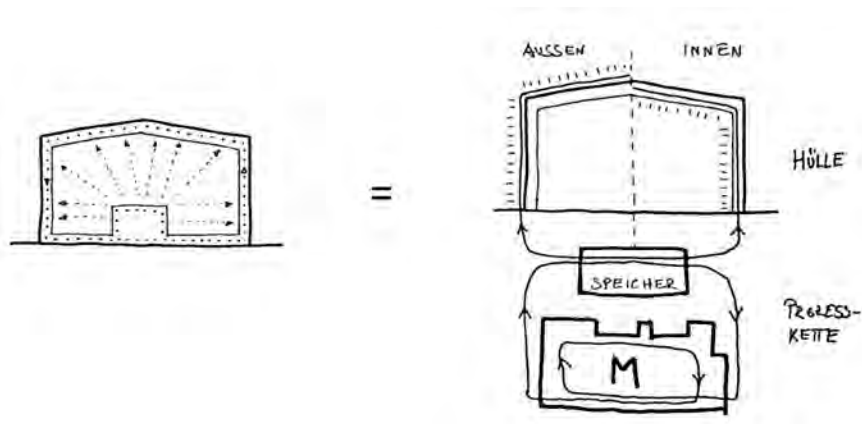

### 1.2 Innovations – guiding principle and concept

To advance our thinking of energy efficiency in the industry means to strike a new path, to develop a novel, holistic understanding of energy efficiency. Rather than following the purely dogmatic approach of 'saving' energy, our intent is to truly comprehend the energy system and to identify the energetic dependencies within it.

The guiding principle and the ETA Factory concepts derived from it are targeted toward using the necessary quantity (ultimate energy demand) of the appropriate form of energy (primary energy demand) at the right time (flexible energy supply) and the right location (efficient infrastructure). All while avoiding surplus capacity within the infrastructure (generation, distribution, storage, transformation). These measures respond to the complex and interacting objectives of reducing the primary energy demand and CO<sub>2</sub> emissions, respectively, the reduction of the ultimate energy demand as well as increasing the load flexibility. Hereby, the focus lies on system efficiency and economic viability of all measures.

An exemplary production process chain from the field of metal processing forms the basic structure of the research. The efficiency potential of the overall system is researched and demonstrated by linking the production processes, the supply technology and building services technology as well as the building and its structure.

With this integrative approach to create the world-first prototype, the ETA Factory project strives toward a new developmental era for the energetically optimised production facility of the future. Hereby, the focus lies on savings potential in the following areas and on their interaction:

- Production machines and interdisciplinary technologies in mechanical engineering
- Technical building services installations and supply engineering
- Building envelope, façade and construction
- Monitoring, managing and mining energy data with "Industry 4.0" approaches
- Load flexibility and control optimisation
- Simulation approaches to plan and operate efficient production facilities

Beyond the objectives of the research, the ETA Factory is also used for educational and demonstration purposes. It thus serves research as well as transferring knowledge to students and commercial enterprises. ■

03 Initial sketches of a thermally networked factory



01

## 2.0 Production process chain

A representative process chain for the metal working industry was chosen to ensure that the results of the research project can be transferred to as many companies as possible. The individual process steps (turning/drilling/milling, cleaning, tempering, grinding, cleaning) cover a broad spectrum of industrial manufacturing (Figures 01, 02), which makes the results relevant for a great variety of companies, but particularly for small and medium-sized enterprises (SMEs) as well, to whose structure they can be transferred.

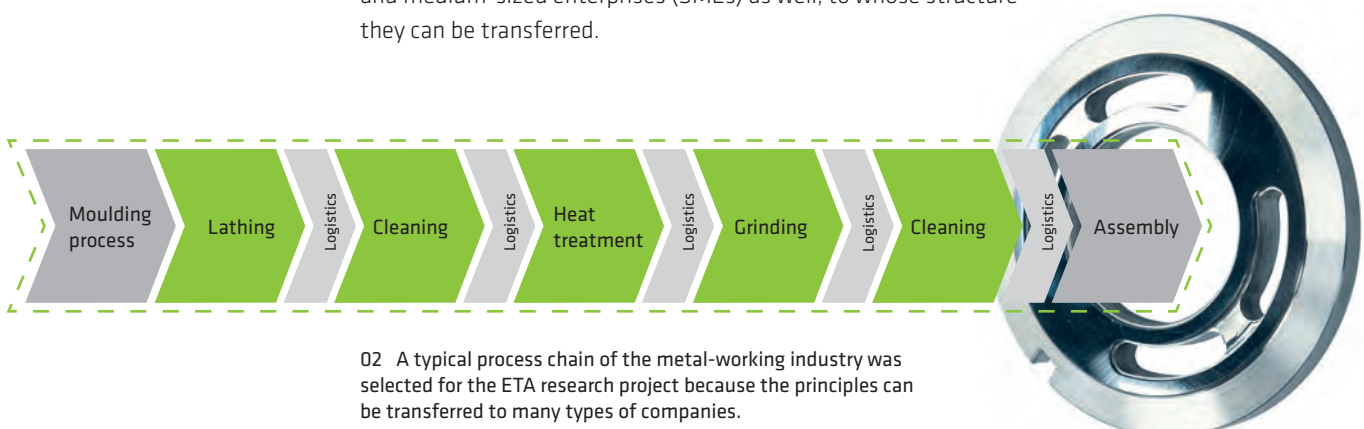

02 A typical process chain of the metal-working industry was selected for the ETA research project because the principles can be transferred to many types of companies.

The process steps serve as the basis to create a demonstration building component in collaboration with Bosch Rexroth AG. The ETA Factory comprises the equipment and technology for two cutting processes, two cleaning processes and one heat treatment process; thus presenting processes that are present at many companies. In addition, the sample machines and the components contained in the machines represent a broad spectrum of interdisciplinary technologies.

### 2.1 Energy efficient metal cutting with machine tools

Regarding its energy efficiency potential, virtually no other production machine has been researched as intensely as the machine tool. For the ETA Factory, the research into machine tools at the Institute of Production Management, Technology and Machine Tools (PTW) forms the starting point of all activities since the turn of the Millennium – and, more recently, for the Maxiem project (Maximisation of the energy efficiency of metal cutting machine tools). In order to reveal hitherto unidentified potential, the ETA Factory is used to advance our thinking around the topic of energy efficiency. The equipment used at the factory (machining centre, vertical turning machine, vertical grinding machine) are designed to save energy without having to interfere with the highly individual, application specific production process. This is achieved with established and commercially available technologies supplied by the project partners as well as developments and innovations that can be market-ready in the short term.

Several findings concerning the energy efficiency of machine tools have been worked out in previous research projects. The focus of the ETA Factory lies on the cooling system and the machines' sources of waste heat. The biggest heat source in the machines, often with a share of a fifth of the supplied total energy, is the motor spindle (Figure 03).

#### 2.1 Authors

Mark Helfert, Markus Weber  
PTW, TU Darmstadt

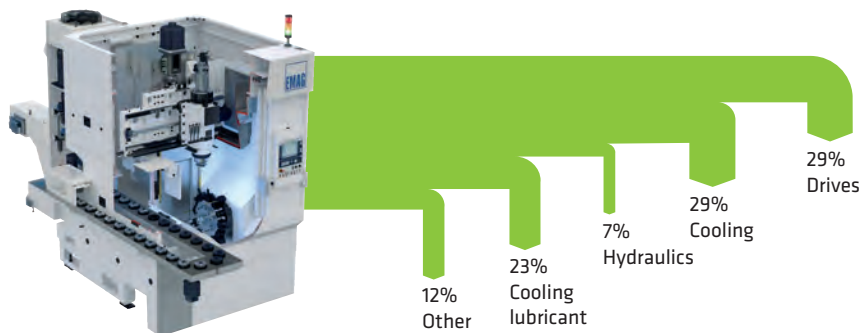

03 Effective power demand of a turning machine – the largest heat source for waste heat recovery are the drives and the cooling system.

Based on the already high efficiency level of the examined machines, the ETA project identified the following measures that offer potential of efficiency optimisation:

- variable-speed hydraulic units,
- demand-controlled cooling lubricant supply,
- reduction of sealing air with optimised labyrinth seals,
- alternative, energy and resource efficient drive variants,
- thermal optimisation of motor spindles, and
- optimally controlled power supply module for drives.

**Waste heat recovery increases the degree of machine utilisation and reduces the energy demand of the building**

During the first step, the individual components of the machines were successfully optimised and their energy demand was reduced to a minimum – by a fifth compared to the reference machine. This was achieved with variable-speed hydraulic units and a demand-controlled cooling lubricant supply, amongst other measures. The implementation of energy monitoring and controlling allowed for a significant reduction of the energy demand during the operational state. The second step focussed on consequently exploiting the waste heat inevitably generated during machine operation. More than 40 percent of the waste heat generated by the vertical turning machine with decentral cooling was recovered in a liquid-bound state and then made available for other processes (Figure 04).

The decentralised compression chiller of the grinding machine was replaced with a heat exchange module developed by EMAG. This meant that the machine and the cooling lubricant could be cooled more efficiently via the central cooling network of the ETA Factory. In addition, the liquid-bound waste heat reduces the heat introduction into the production hall, which, in turn, lowers the energy demand required for the building’s climate control.

04 Effective power demand of the vertical turning machine EMAG VLC100Y and the share of usable waste heat

**Energy efficient drive systems in motor spindles for thermal optimisation**

Part of the project was the design, development and construction of several demonstrator motor spindles. The focus lay on two motor spindles identical in

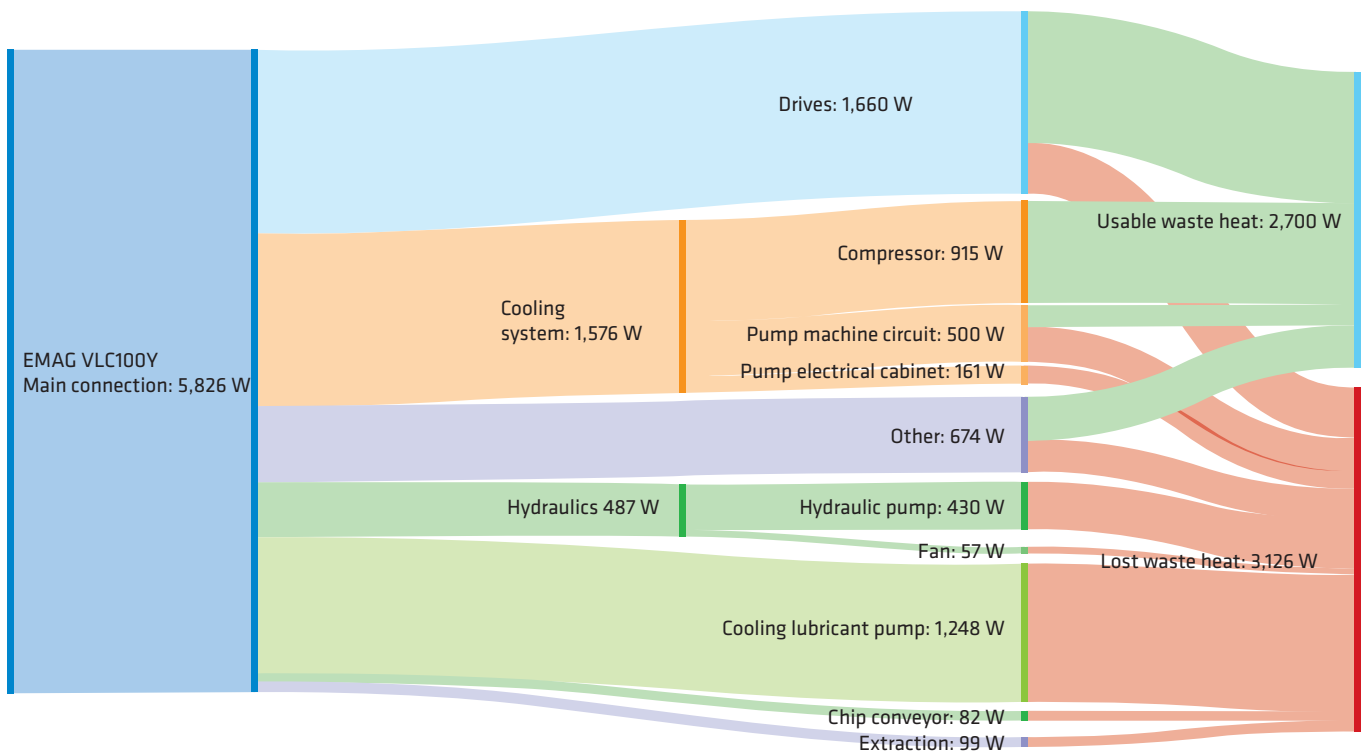





performance and construction with different electrical drive systems: synchronous reluctance motor (SynRM) compared to asynchronous motor (ASM). Here for, the motors were examined on a test bed to determine the losses and the degree of efficiency as well as to analyse the thermal behaviour (Figure 06).

05 Heat exchange module of the vertical grinding machine EMAG VLC100GT

Since there is no rotor-related loss of copper with the SynRM, its losses for all load requirements account for only half of those of the ASM. The efficiency level of the SynRM is around five percent higher in all operating points. Even if the conversion losses are taken into account, the entire SynRM features less power loss than an identically constructed ASM.

06 Test bed at PTW with SynRM test item and load machine

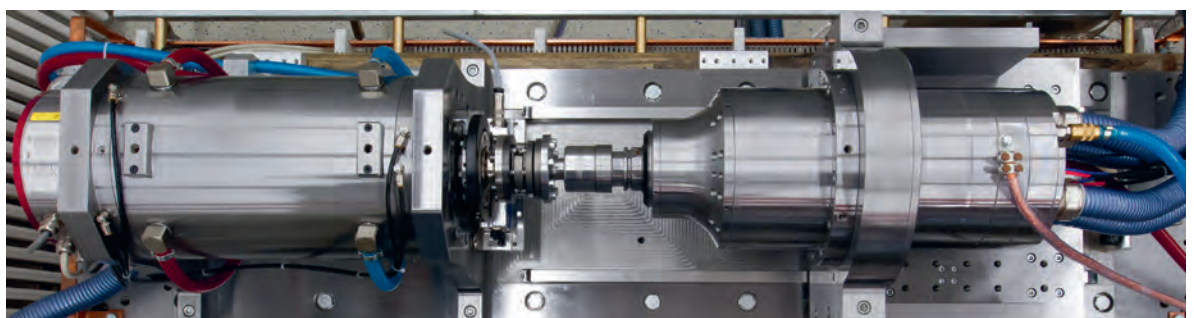

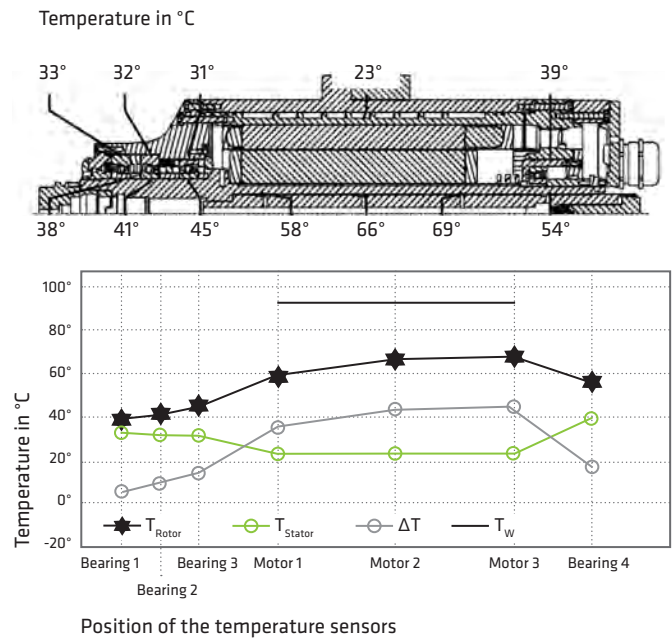
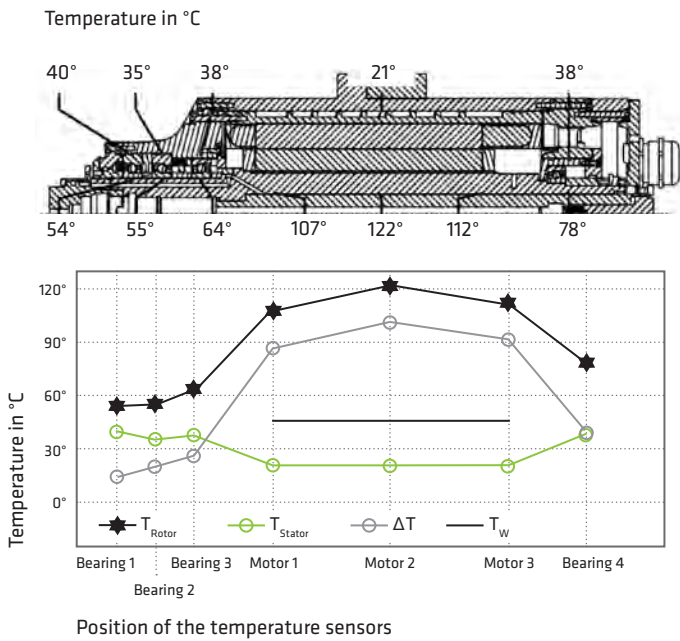

07 Stationary temperature distribution in the ASM (left) and the SynRM (right)

Stationary temperature distributions at the operating point with maximum losses were measured for a thermal analysis. Overall, the SynRM features lower system temperatures and the temperature distribution is more even (Figure 07). This benefits the thermal behaviour of the spindle system. As a result of heat induced expansion of the spindle shaft with SynRM, the shift of the planar support at the tool interface is half that of a system with ASM, which results in a better machining result.

### 2.2 Energy efficient component cleaning

In terms of energy efficiency, aqueous component cleaning is a relatively new academic research field. In the industry, however, it offers great potential for application. The objective of the approach is to transfer the experience in the field of machine tools to the field of cleaning machines, on the one hand, and to broaden our understanding of the system, on the other. The energy demand required for the cleaning process is directly dependent of the degree of contamination of the components. Thus, the process management of the last shaping metal cutting process plays an important role, and is therefore subject to in-depth research at the ETA Factory. At the same time, a thorough examination of the process chain offers

#### 2.2 Authors

Felix Junge  
PTW, TU Darmstadt

Joachim Schwarz  
MAFAC-E. Schwarz & Co. GmbH

Andreas Krönauer  
Bayerisches Zentrum für Angewandte Energieforschung e. V.



Distribution of the energy demand of an automotive production [%]

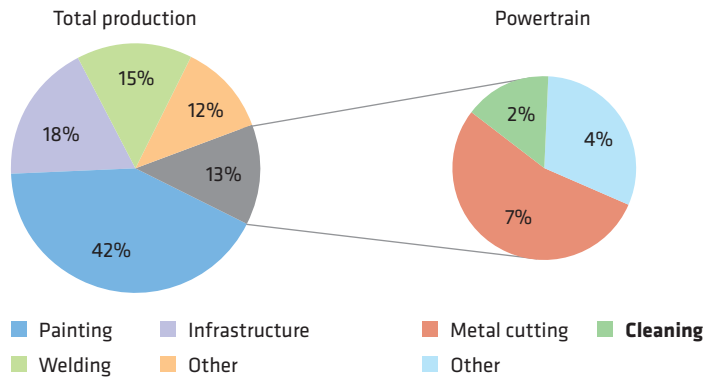

the possibility to exploit hitherto unused waste heat for other purposes. The ETA Factory was the first place where the waste heat from machine tools was used to heat the bath of the cleaning machines with the help of heat pumps (see chapter 3.1).

09 Percentage distribution of the energy demand of the production of an automotive manufacturer; two percent apply to cleaning processes (entire factory); if applied to the powertrain production, the share rises to 16 percent.

**High energy demand for industrial cleaning processes**

In the industry, components are typically cleaned before assembly or to prepare the surface for painting, heat treatment or similar process steps. Cleaning is usually conducted with wet methods, mainly ultrasonic cleaning, liquid immersion cleaning and spray cleaning. Following a study, cleaning as part of automotive production accounts for approximately two percent of the overall energy demand. Powertrain manufacturing consumes even more energy; the energy share required for the cleaning process is approximately 16 percent (Figure 09).

**Innovation in the field of industrial cleaning and corresponding production equipment**

In order to accommodate the energetic relevance and the multitude of application requirements, the team of the ETA Factory examined and developed energy saving concepts for the following aspects:

- full thermal protection/insulation of cleaning systems,
- prevention of waste heat,
- reduction of moist exhaust air,
- internal reuse of waste heat,
- heat recovery from component drying,
- heat exchanger for cleaning agents,
- embedding cleaning systems in central heat supply systems,
- optimisation of cleaning processes,
- analysis of special processes using laser technology,
- strategies to avoid contamination and
- to adjust chemical cleaning agents to lower the bath temperature.

10 Thermographic examination in the machine room of the cleaning system

11 Feeding of the laser cleaning system



10



11

Heat demand:

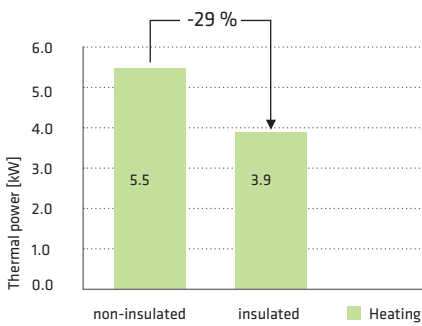

Additional advantages due to thermal insulation of the machine:



Reduction of the sound emission by 9 %



Reduction of the thermal radiation about 30 %

12 Performance comparison of the non-insulated and insulated cleaning machine used in an ETA cleaning process

Two of the previously mentioned concepts are discussed in more detail in the following to offer thorough insight into the developmental work.

*Full thermal protection/insulation of cleaning systems*

In order to optimise the energy balance of the MAFAC JAVA cleaning system, it was prototypically insulated following the “thermos flask principle” (Figure 12). Measurements showed that insulating the cleaning system can reduce the heat requirement to heat the bath during a cleaning process by up to 29 percent. With reference to the total energy demand of the machine, the optimisation potential averages about 21 percent; a significant amount.

And the cooling demand of the production plant is lowered at the same time. Other positive side effects result from an improved sound emission behaviour of the system: the sound power level decreases by approximately nine percent compared to a non-insulated system.

*Heat recovery from component drying*

A solution to recuperate the waste heat from the exhaust air of the drying process was developed within the scope of the project to further reduce the energy loss during component cleaning. It consists of a heat pump, which, on its cold side, condensates the residual humidity in order to cycle it back to the cleaning tank (Figure 13). Heat on its warm side is used to keep the temperature of the cleaning agents on a constant level. This optimisation results in 15 % less electric energy demand, because of the better energy efficiency of the heat pump compared to the electrical heating of the cleaning agents.

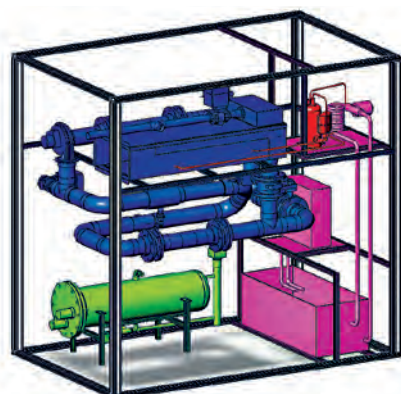

13 Model and setup of the heat pump module

### 2.3 Energy efficient heat treatment

Heat treatment is a particularly energy intensive process, which is why machine-related energy savings have a strong impact on the total energy demand of the factory. Thus, the concepts tested on the demonstrator (gas nitriding furnace IVA RH655) of the ETA Factory are aimed at minimising the energy consumed by the main process as well as the supplementary processes. At the same time, they show the significance and the special potential of internal (waste) heat recovery.

A manufacturing plant that realises these optimisation measures can save more than 40 percent of the total energy demand and, at the same time, reduce process gas consumption.

#### *Innovations in the field of heat treatment*

In 2016, the total energy consumption of the production of metal products comprised approximately 25 TWh. This makes this sector one of the most important energy consumers of the German industry [DESTATIS]. In 2010, around 30 percent of the energy was used for surface finishing processes, which belongs to heat treatment. The ETA project identified the following eleven aspects that pose a saving potential:

#### 2.3 Authors

Christoph Bauerdick  
PTW, TU Darmstadt

Dr. Klümper-Westkamp  
IWT Bremen

14 Cooling of the furnace through the hall network with serial-connected cooling circuits to increase the starting temperature

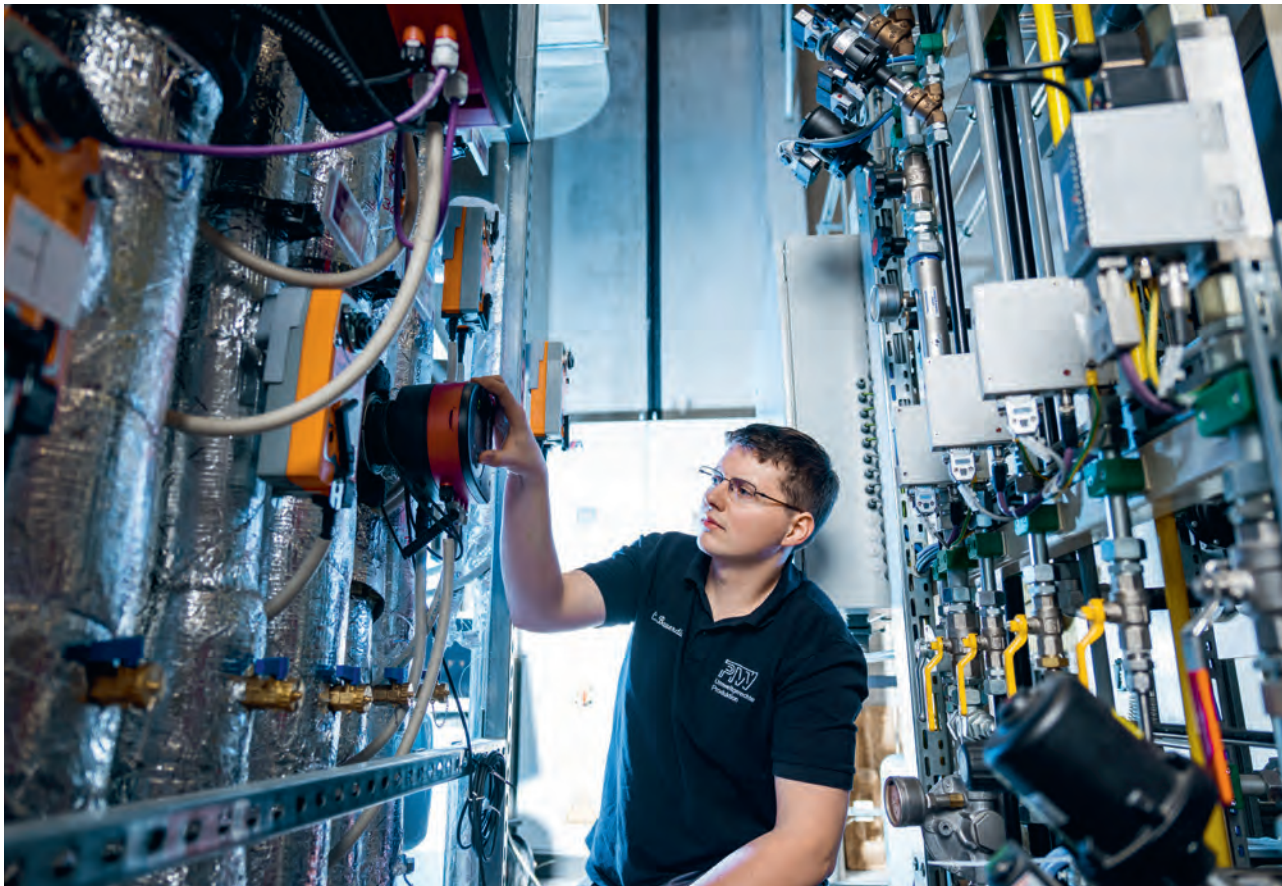

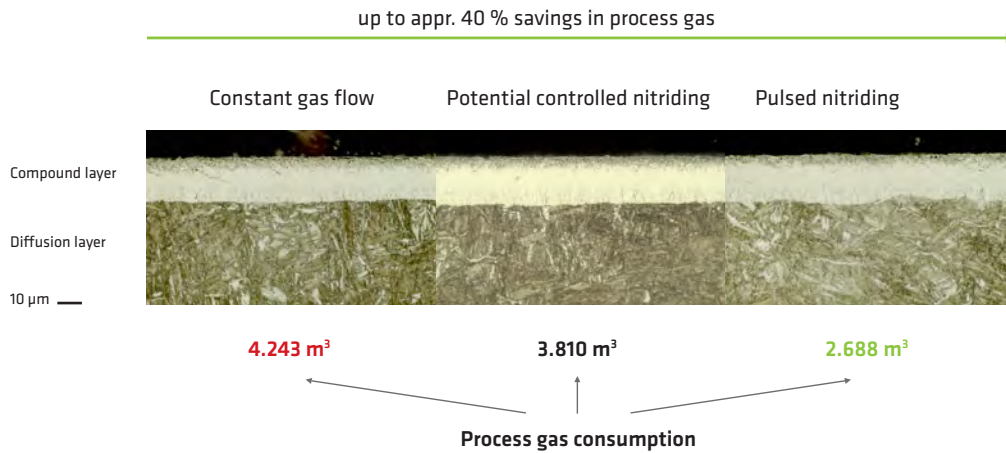

15 All three variants show the formation of equally thick compound layers: left with permanent gassing, centre with potential controlled nitriding, and right with pulsed nitriding.

- potential controlled nitriding,
- pulsed nitriding,
- development of a more efficient surplus gas burner,
- surface insulation of the furnace,
- serially connected cooling circuits to increase the starting temperature,
- waste heat exchanger for surplus gas burner,
- recuperator burner,
- control of the combustion air blower,
- slower cooling process,
- lower circulation speed and,
- CFC charging rack.

**Reduction of the process gas consumption with potential controlled and pulsed process management**

Process gasses such as ammonia and carbon dioxide are needed for surface layer hardening based on gas nitriding or gas nitrocarburizing methods. In most furnaces, the process gas is fed into the hot reaction chamber (500 to 590 °C) in a continuous volumetric flow. This ensures a permanent surplus supply of process gas to guarantee a stable reaction. Excess process gas is purged and burned. Two variants to save process gas were examined:

1) Potential controlled nitriding: controls the ammonia and hydrogen ratio inside the furnace with sensors. The amount of process gas flowing in is controlled precisely to generate an ideal reaction atmosphere. However, a permanent flow of process gas is necessary to prevent air from streaming in the furnace.

2) Pulsed nitriding: the process gas is not fed continuously into the airtight furnace but rather in time intervals and with a slight overpressure. The process gas in the furnace is replaced after ten minutes.



The results are shown in figure 15: it shows that both methods generate equal compound layer thicknesses as with constant gas flow. But the gas consumption decreases by approximately ten percent with potential controlled nitriding, and by almost 40 percent with pulsed nitriding.

16 Surplus gas burner with waste heat exchanger

#### *Development of a more efficient surplus gas burner*

One of the largest energy consumers of gas nitriding or gas nitrocarburization is the surplus gas burner. The burner is needed to burn excess process gas, which could otherwise endanger the environment. They run on fuel gas (natural gas) and air. The hydrogen contained in the exhaust gas (50 to 75 percent during nitriding) keeps the burning process running. This means that, generally, the energy contained in the exhaust heat of the surplus gas burner deflagrates and is lost. However, part of the waste heat could be recovered with a waste heat exchanger (Figure 16).

But it is much more efficient to integrate the surplus gas burner right into the furnace heater. Therefore, part of the project involved developing a new recuperator exhaust gas burner. Recuperator burners exploit their own waste heat to preheat incoming fuel gas, a process that significantly increases the efficiency of such a furnace. The test series with the demonstrator showed that the developed waste gas burner has to be preheated to around 900 °C initially, but that the natural gas supply can then be interrupted, because the hydrogen share of the waste gas suffices to maintain the required temperatures for safe after-burning. This meant that the ETA project saved more than 20 percent of the natural gas required for the hardening process.



17



18



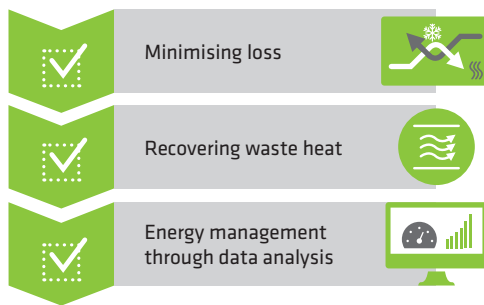

19

The newly developed surplus gas burner can now be developed further to integrate it into the furnace heater. However, this requires a safety concept because possible process gas concentration inside the combustion chamber must be avoided at all cost.

*Minimise effective energy, increase efficiency*

Across different machines and topics, the researchers participating in the ETA project have identified many potentials and developed solutions to conceptualise and operate production machines more energy efficiently. Based on a value-added production process, the suggestions for improvement focus on minimising the needed effective energy and to increase the efficiency during the transformation into the required form of effective energy. This can be done by designing the components such that energy is only supplied and consumed as needed. In the same manner, the connected load, for example, as well as the emitted waste heat of the machines and related components, which might require cooling, can be reduced. Intervention on a component level thus has an immediate effect on the supply infrastructure as well as the room climate of a factory. Optimisation of individual interdisciplinary technologies does not imperatively depend on the particular application, and can therefore be transferred to many other industry sectors. In principle, loss can be minimised, waste heat recovered and improved energy management achieved with data analysis in any factory and for any machine (Figure 19). ■



20

17 Insulating the machines and components results in a significantly lower total energy demand.

18 Newly developed waste heat burner (test setup)

## 3.0 Energetic networks

### Authors:

Martin Beck, Nina Strobel,  
Niklas Panten  
PTW, TU Darmstadt  
Michael Richter  
IMS, TU Darmstadt  
Collaboration with:  
ZAE Bayern e. V.  
IWB, Uni Stuttgart

The forms of final energy used for the process chain of the ETA Factory are electricity and natural gas, both of which are drawn from superordinate supply grids. In the factory, they are transformed into other forms of energy (heat, cold, compressed air) or directly used by the production equipment. Various energy storage systems can decouple the supply of final energy from the actual use by the production machines. This allows an efficient use of available environmental energy (low night temperatures, for example). Furthermore, interlinking different forms of energy and different systems offers the advantage that hitherto unused waste heat can be fed back into the supply network, to increase efficiency on request.

### 3.1 Thermal crosslinking

Whenever heat is transported from a source to a sink, this creates thermal crosslinking. A corresponding exchange occurs, for example, between the components of a production machine and the ambient air. Alternatively, as well as additionally, heat can be transported through a water-based cooling circuit.

Targeted thermal crosslinking makes it possible to utilise waste heat in order to allow for efficient recooling of non-usable waste heat to a heat sink outside of the system boundary

Typical temperature ranges of waste heat sources		Typical temperature ranges of heat sinks	
Room exhaust air	16 – 30 °C	Room supply air	16 – 26 °C
Exhaust air from cooling processes	20 – 60 °C	Aqueous cleaning baths	50 – 85 °C
Return flow from cold and cooling water systems	20 – 60 °C	Room heating	30 – 80 °C
Exhaust gas from burning processes and process engineering applications	50 – 450 °C	Heat exchangers (sorption chiller, ORC processes, etc.)	60 – 650 °C

01 Typical temperatures of a metal working production process chain

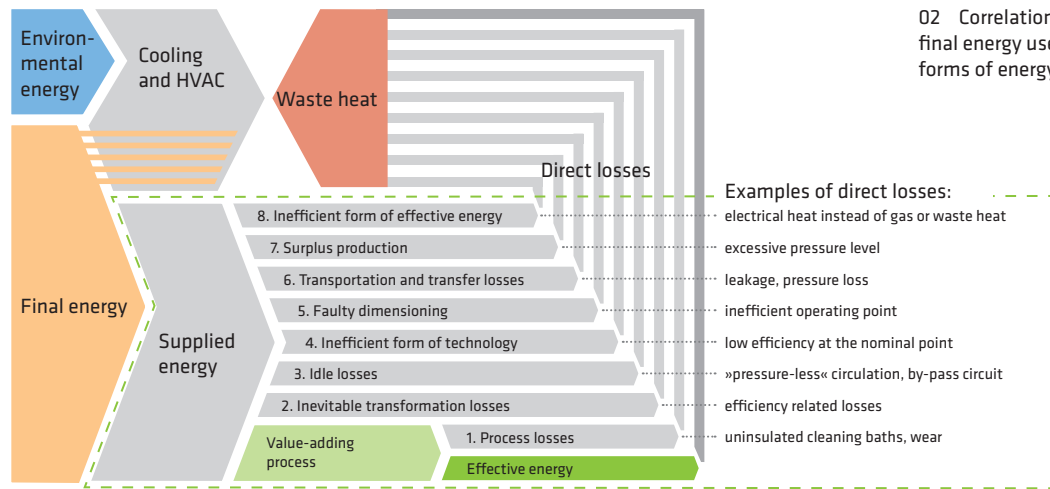

02 Correlation between the final energy use as well as the forms of energy wasting



of a production operation. The typical temperatures of waste heat in the surroundings of metal-cutting processes/machining production depend in the particular application (Figure 01, left column).

*The amount of waste heat resulting from a process is an indicator of the efficiency of the production*

In the context of mechanical production, final energy is almost entirely transformed into waste heat (Figure 02). The lower the amount of accruing waste heat, the higher the efficiency of a production environment. Furthermore, waste heat creates follow-up costs, if it requires that the production facility needs to be cooled.

Based on the optimisation of individual machines (see chapter 2.0), the objective of networking is to optimally integrate and embed residual heat flows. Three water-based, thermo-hydraulic pipework systems form the basic technical setup of the thermal crosslinking in the ETA Factory:

04 Technical realisation of the thermal crosslinking at the ETA Factory

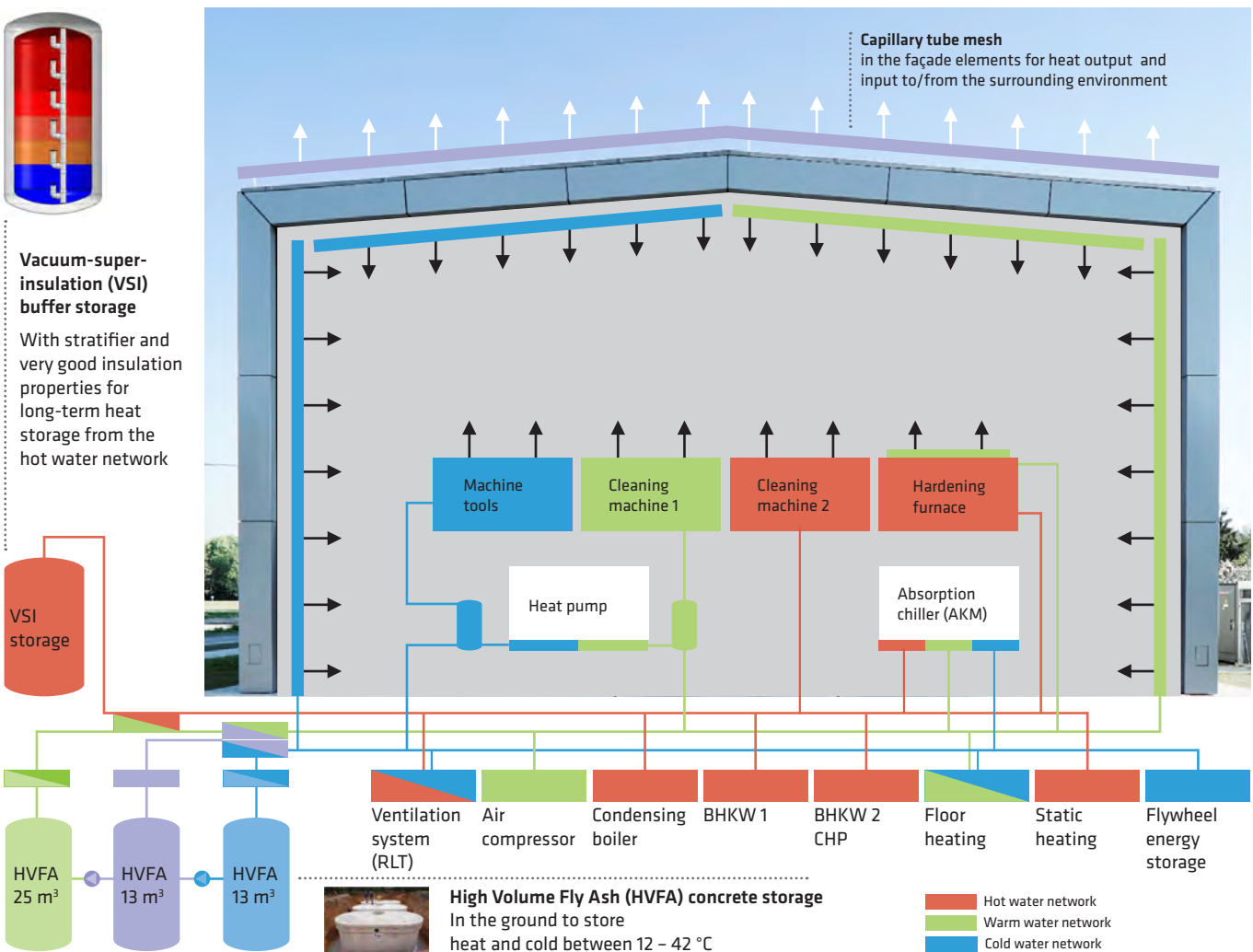

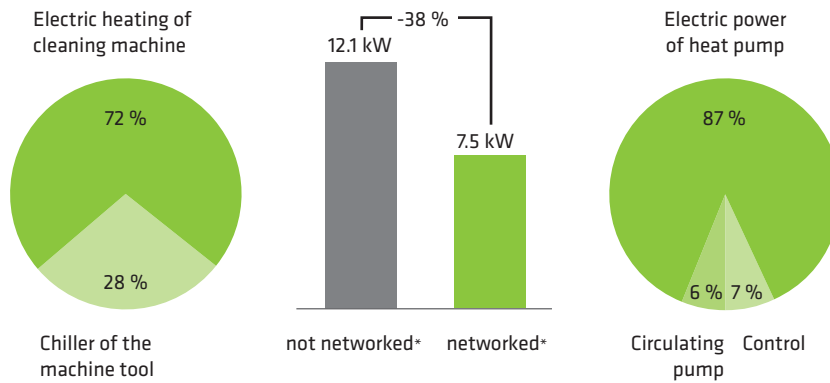

\*Assuming an average cooling load of 7.2 kW and an average heating load of 8.7 kW

- a cold water network (10 to 20 °C) to cool the production machines and the building during summer conditions;
- a warm water network (30 to 40 °C) to recool or heat other machines as well as for low temperature heating of the building during winter;
- a hot water network (70 to 85 °C) to supply the absorption chiller, with high temperature waste heat from the furnace as well as from two cogeneration units and a condensing boiler.

This basic setup is typical for the industry, it integrates all of the systems shown in Figure 04. Depending on the operation scenario, individual components can be connected to appropriate networks. This means that production waste heat can be dissipated via the building envelope in summer, and used to heat the building in winter.

**Monitoring results from simulation and the operation of thermal networks**

The entire system ETA Factory can be tested in different scenarios in real operation mode. More than 2,000 implemented data points record the results from a particular point in time, allowing a detailed analysis. One example of thermal crosslinking on the machine level is using the waste heat generated by machine tools (Figure 05). Supported with a heat pump, this low temperature level is used to heat the cleaning processes.

05 Verified savings exemplified by networked machine tools and cleaning machines

06 Performance of the capillary tube mesh during cooling of the cold and warm water network

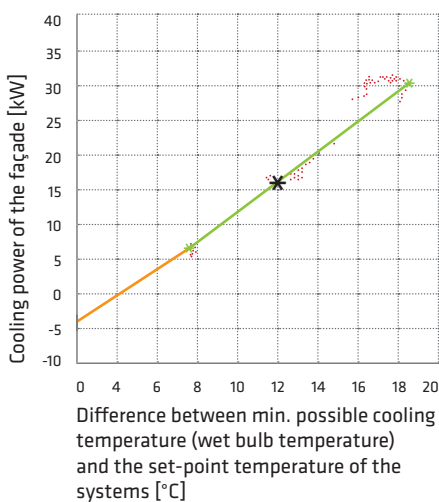

\* Marked example:  
 Available cooling power for the machine tools at a wet bulb temperature of 8 °C and a required set-point temperature of 20 °C  
 (→ difference = 12 °C) = appr. 16 kW

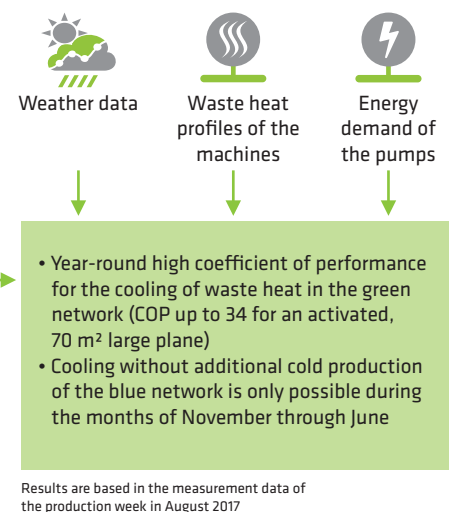

Results are based in the measurement data of the production week in August 2017



07

In addition to increased efficiency on the machine level, this measure achieved additional savings of approximately 40 percent.

In addition to creating a network on the machine level, in the ETA-Factory the building itself is connected to the network to analyse any potential increase in efficiency related to this measure. Based on the waste heat profiles of the various production machines, on weather data and the electric energy demand of the pumps, the project examines the performance of the activatable exterior façade in terms of its function as a central element of the thermal network (Figure O6). This measure proved to result in efficiency gains, as did using the activated interior

08 Results from the simulation model of the thermal crosslinking

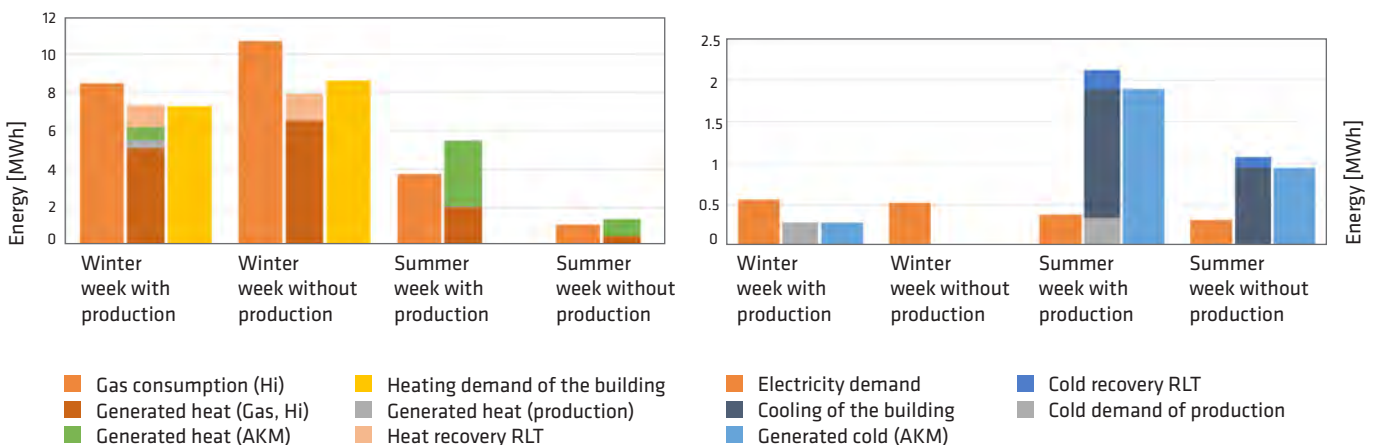

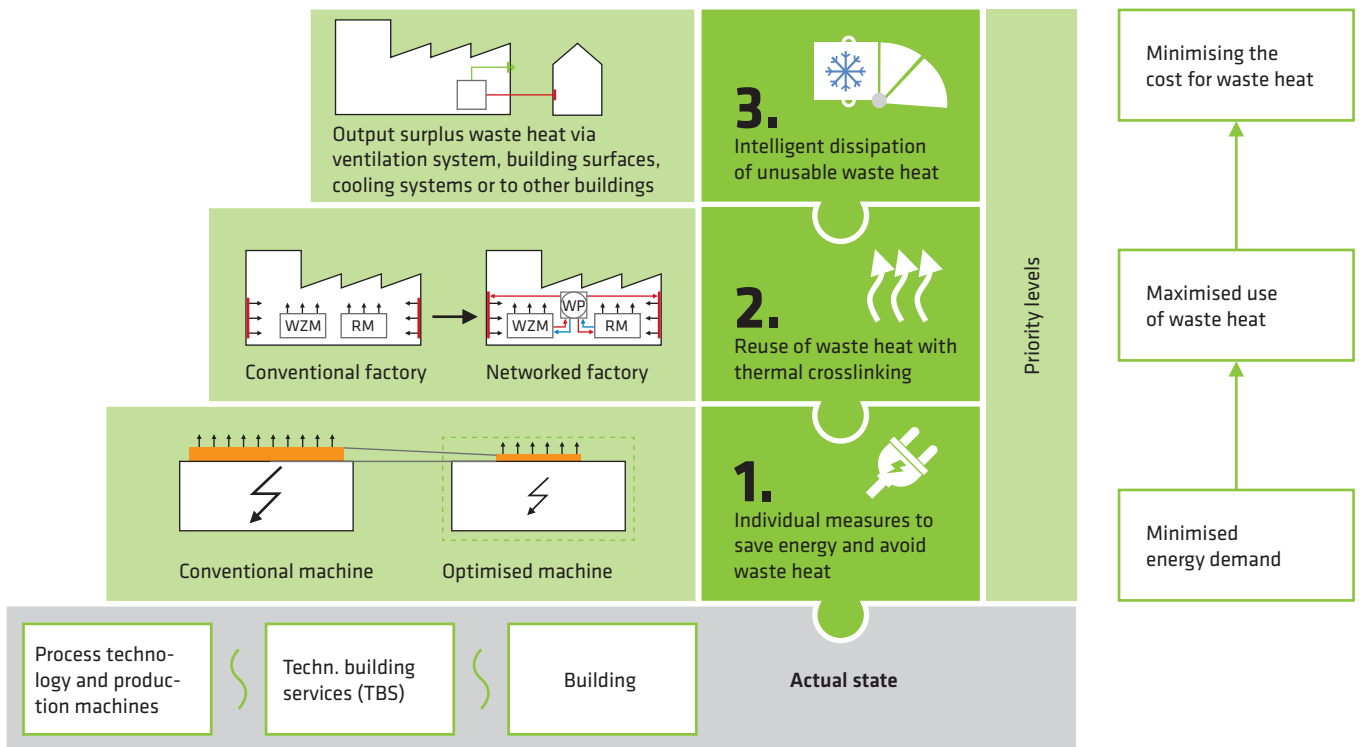

façade for summer and winter climate conditioning.

Simulation models were parametrised using the recorded measurement data. These models were used to predict the energy balance of the overall system in different operating scenarios (Figure 08).

*Energetic networking increases efficiency but it also creates dependencies.*

A thermo-hydraulic network as the foundation for thermal linkage allows to efficiently collect and dissipate waste heat from the production process. The waste heat can be efficiently dissipated to the surrounding environment or for further reuse. Before installing a thermal crosslinking, all machines and components must also be optimised in terms of their efficiency (Figure 09). Energetic networking creates energetic as well as local dependencies that must be carefully considered. However, thermal crosslinking will increase the efficiency of a factory in the sense of primary energy savings.

09 The bottom-up approach developed for the ETA Factory for optimum waste heat management



### 3.2 Energy data in the ETA Factory

The energy demand and the actual state of the energy system of a process chain must be established to ensure future-proof and thus effective investment, and to reduce the energy demand as well as the cost. Against this background, more than 2,000 data points of the ETA Factory are consistently measured, recorded and evaluated with various sensors and actuators.

#### *Thematic classification and relevance*

“You can’t manage what you don’t measure” is a well-known saying in management circles, which is at least as true, or even especially true, in the context of production energy management. Whereas numerous studies and research projects highlight the significant potential of economically viable energy efficiency increases in the German industry, realisation mainly fails due to a lack of founded data. But well founded data is mandatory for an analysis of the effect of energetic and economic measures. In this context, one particularly challenging domain is the





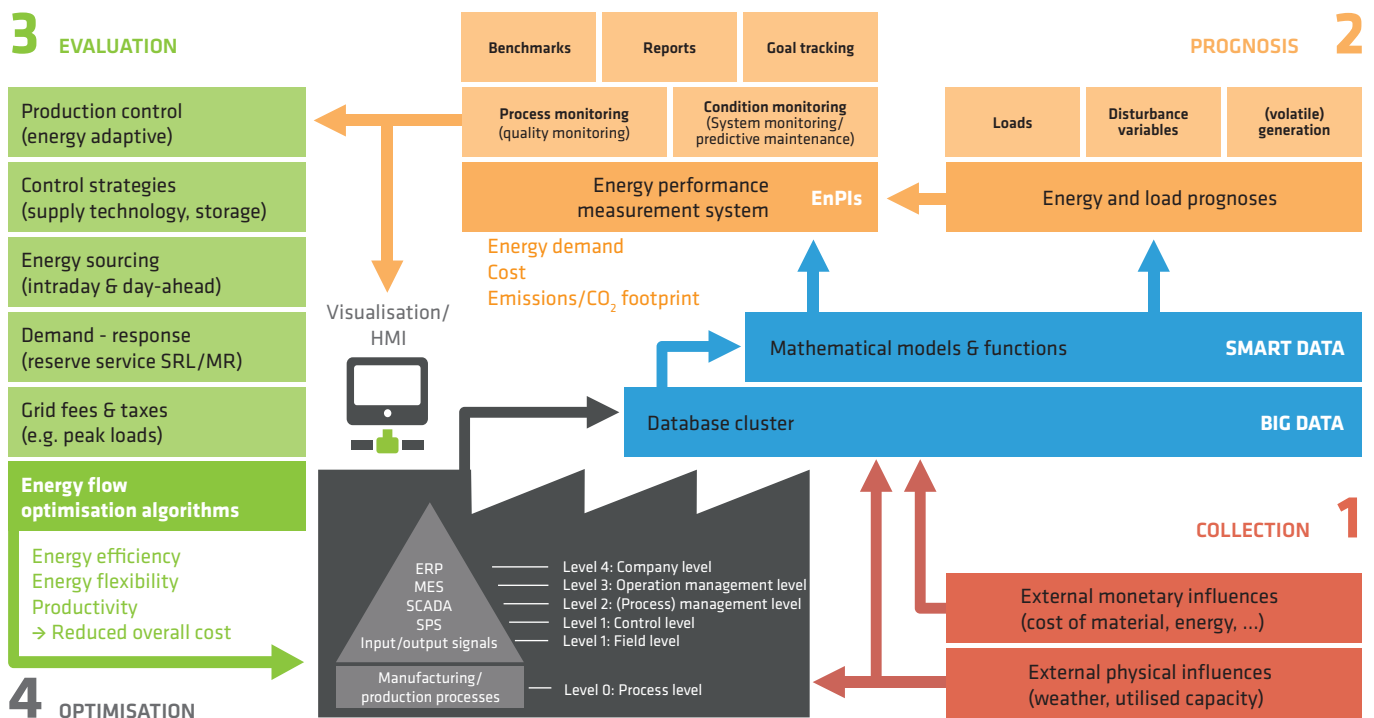

evaluation of energy flows, an aspect often underestimated by companies. Because energy flows usually are

- not immediately visible,
- highly dynamic,
- omnipresent with regards to place and time, and
- always distorted by a multitude of time-variable influencing factors.

Owing to appropriate measuring devices and advanced information technology, detailed energy monitoring can be used to systematically record the energy flows, which can then be correlated with relevant influencing factors such as weather or production data. The data puts researchers and energy managers in the industry in the position to thoroughly comprehend the energetic reciprocal action. It documents the success of energy management projects and gives an indication of the future energy demand. Effective energy monitoring also alerts early about excessive consumption, resulting, for example, from a device or machine malfunction, undesirable user behaviour or maintenance not carried out at all or too infrequently.

The superordinate objective is always to derive well-founded measures from the obtained energy data in order to reduce energy cost and emissions. Increasing energy efficiency is one thing, but we also need to identify efficient strategies for system demand control and to optimised energy generation.

12 Energy data flow from data collection to optimisation

*Project results in the field of energy monitoring*

Part of the project was to develop a methodology to design a suitable monitoring system. Necessary points of measurement for different energetic cost, usage and influencing values can be identified based on the individual objectives of the energy management on company, area or system level.

A determination of the true energy demand under real operating conditions requires significant investment in measuring equipment. Therefore, measurements are often conducted and recorded on the aggregated system level alone. The ETA Factory, on the other hand, was equipped with a comprehensive energy monitoring system that includes all system specific parameters. Here for, a multitude of energy and process data is made available on the control level via a standardised OPC-UA communication protocol. An energy monitoring software application retrieves the data and archives it in a database.

Increasing area-wide energy transparency in the industry means that the cost for procurement, installation and connection of points of energy measurement must be reduced unconditionally. Against this background, sensor reduced energy data collection concepts were examined and developed. The methods used involve coupling the sensor data collected with “intelligent” components with system models, or using algorithms to disaggregate aggregated points of measurement (e.g. at the main connect) in combination with process data into their subordinate components.

A flexible and powerful data analysis platform was developed to be able to collect and process highly frequent machine data (e.g. of variable-speed drive systems). The web-based Data Analytics Server consolidates and analyses machine and process data to increase the availability and productivity of manufacturing equipment. The software exploits predefined mathematical methods as well as visualisation to analyse the energy data to provide quality control of the production process, process improvements and preventive maintenance.

A necessary subsequent step within the scope of the energy management is to condense the large amounts of data into meaningful figures for the different

13 Principle of the energy data collection in the ETA Factory

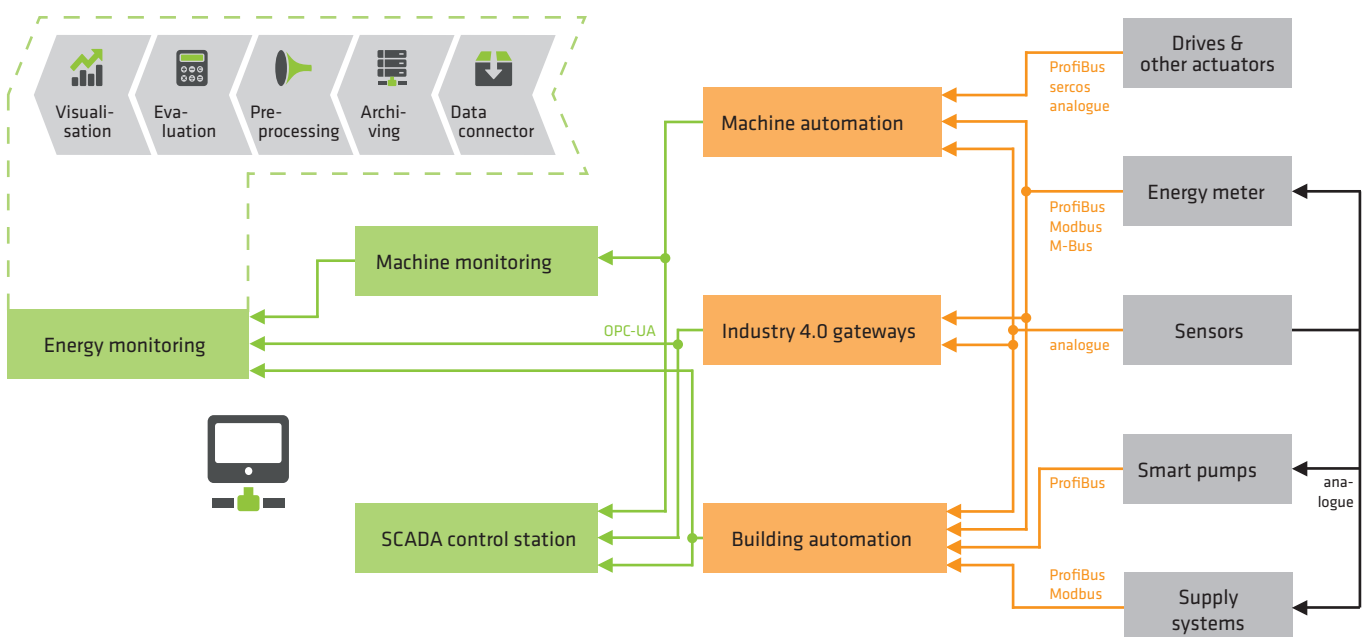



14

target groups. Within this context, a comprehensive performance measurement system was developed, specifically designed to adequately assess the complex, energetic interaction of the ETA Factory.

#### *Conclusion and prospect*

The collection of energy data and an intelligent analysis and evaluation therefore are key enablers for successful energy management. The ETA Factory exemplary demonstrates how energy demand for production can be made transparent and how energy data can be gainfully processed. Novel business models increase the significance of digitalisation, and draw attention to the manifold optimisation potentials. Therefore, the availability of high-quality data and their value will continue to rise exponentially. The fact that precisely this type of data can be comfortably generated and analysed in the ETA Factory is the basis for follow-up projects that deal with the automated, intelligent evaluation of these data volumes. Powerful hardware and innovation in the area of machine learning and optimisation now allow for a variety of research approaches for various applications arising from the network of the ETA Factory (e.g. prognosis, predictive maintenance, operation optimisation).

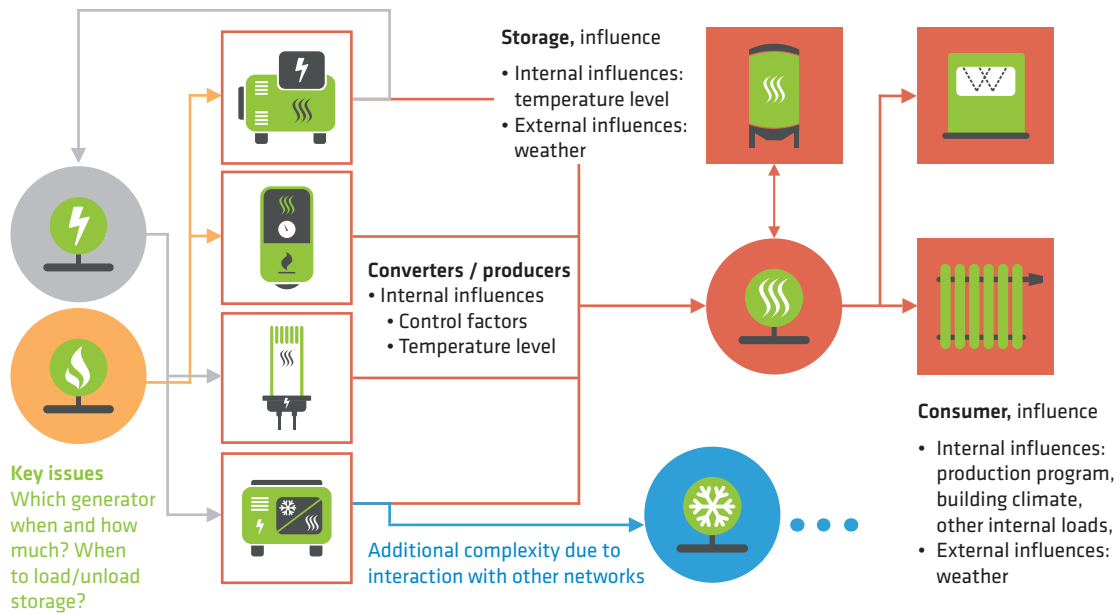

15 Principle schematic of the energetic networking and the aspects concerning energy flow control

### 3.3 Energy flow control in the ETA Factory

The energetic networking of the individual systems in the ETA Factory with different energy transformers and storages as well as many pumps and valves require that all actuators are carefully orchestrated. To do this, information technology was used to connect all actuators of the building services and supply installations to an automation system whose program sequence ensures that various types of supplies are prepositioned. Active load control of the systems offers additional cost savings.

*Next to the energy efficiency, energy flow control also determines the productivity of a factory.*

A production facility can only be productive if the necessary supplies (e.g. electricity, heat, cold, compressed air) for the operation of the production machine are available on demand. However, if the supplies are made available permanently, meaning during idle time, as well, and at exergy levels that are too high, the resulting undesirable operation modes cause a loss of energy efficiency – including during supply transportation and storage. Another problem – especially in thermally networked production environments – are different types of energy transformers that provide a specific required form of energy (multivalence principle, e.g. heat from natural gas or electricity). The specific operating cost for these energies can differ greatly depending on the condition of the equipment, the networks and the energy market. Furthermore, the mode of operation of the systems has an impact on the peak loads at the network connection points, which, in turn, are subject to technical restriction and cause cost due to load-dependent grid fees.

An intelligent operational management takes these manifold requirements into account and regulates the actors to achieve a constellation of energy flow as efficient as possible. The many time-variable influencing factors, non-linear system properties and complex energetic interactions prove the relevance of energy flow control, and, even more so, its optimisation as a challenging research domain.

### Project results in the field of energy flow control

Setting up a consistently IT networked, centralised supply automation in the ETA Factory meant creating the most important basic parameters for efficient energy flow control. Numerous sensors and actuators are read out and controlled via an industrial control system and various digital field busses and analogue signals.

An automation and control program specifically designed for the ETA Factory adequately regulates the valves, pumps and equipment, and controls the energy flows from the source to the sink. The exergy levels demanded by the individual consuming device are dynamically communicated by the systems during the runtime of the program. Based on this information, the program calculates appropriate nominal values and control-based priorities for the generators and networks to turn energy converters on or off. An interface specifically developed for the purpose allows for safe overwriting of the pre-set operating values by external optimisers via OPC-UA.

A web-based SCADA user interface was created for ETA's process control to be able to monitor and manually control the systems. Furthermore, an active load management system balances out electric peak loads of the machinery in operation. To do so, various optimisation processes were developed that shift the schedule of certain operational processes to reduce the peak loads on the component and machine levels.

### Conclusion and prospect

Optimising the energy flow in a production environment is key to reduce energy costs. The establishment of the ETA Factory and its fully IT networked infrastructure created an Industry 4.0 test field that allows testing innovative control and optimisation processes on the component, equipment and system level. Subsequent projects are intended to develop scientifically up-to-date optimisation approaches in order to optimise the cost of equipment in real time operation. This includes a model-based, predictive control, mixed integer optimisation, and reinforcement learning (keyword "artificial intelligence").

16 Screen shot of the web-based building process control user interface

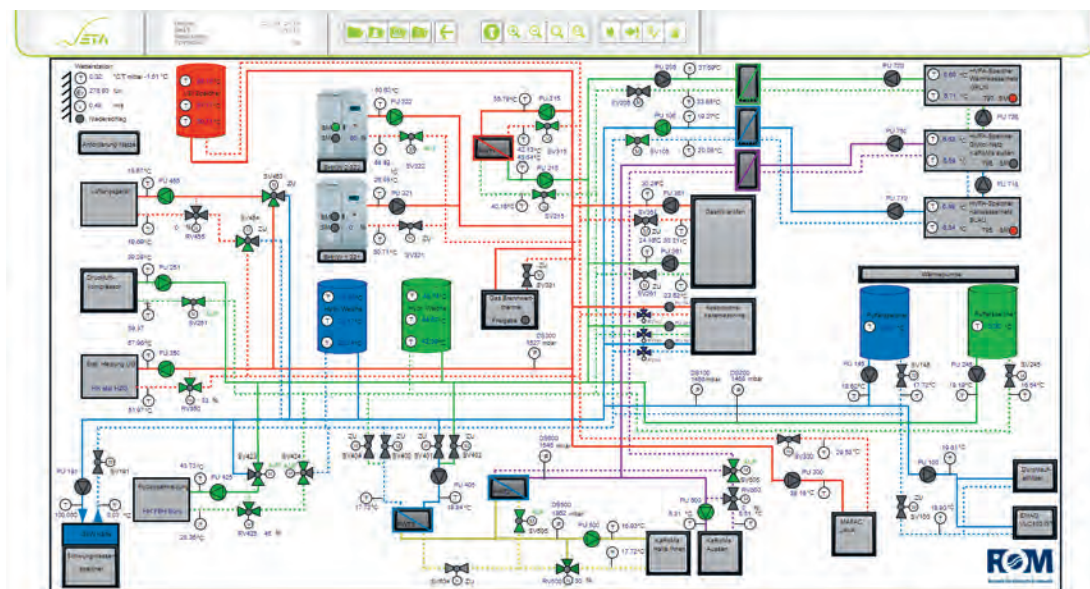



17

### 3.4 Kinetic energy storage

Kinetic energy storage can store electric energy in the mechanical rotational movement of a flywheel mass. The conversion of energy takes place via a motor-generator-unit, which is connected to the flywheel mass and either accelerates it to charge or decelerates it to discharge energy. The storage system in the ETA Factory was built according to the new outer rotor topology type. It serves to smoothen the load curve and to reduce the peak power input of the factory (Figure 18).

#### *Improved utilisation of the electric operating resources and increased power grid stability*

The load profile of process chains in the manufacturing industry is composed of the sum of the load profiles of the individual participating machines. The machines differ in process times, individual load profile and peak input power. The result is a stochastically assembled load profile. Converting conventional energy supply toward renewable energy sources with fluctuating input into the electric grid increases the risk that the grid becomes overloaded. And it is this risk that the energy efficient factory as an integral part of an intelligent grid is intended to counteract. As a result, the share of renewable energy can be increased and

18 Daily load curve in a manufacturing plant with smoothed load curve and reduced power input.

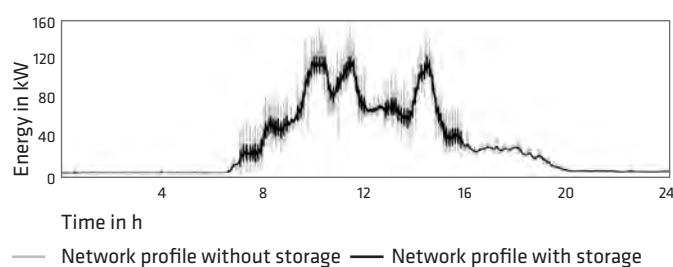

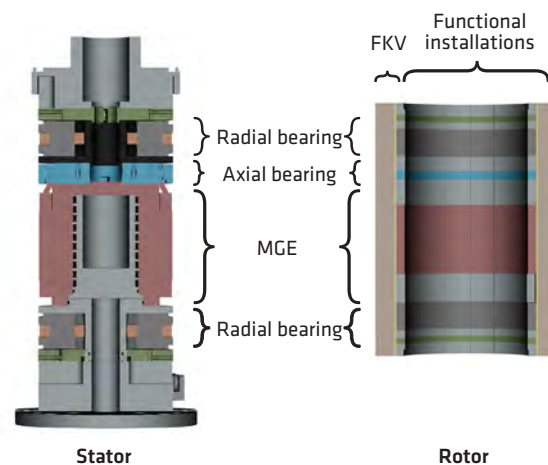

19 Schematic drawing of a kinetic energy storage with external rotor

reserves typically provided by conventional power plants can be reduced. An increase in efficiency arises primarily from holistic approaches and measures. On the factory level, electrical operating resources can be better utilised and the amount therefore reduced. A kinetic energy storage contributes to such improvements by:

- Reducing possible system perturbation of manufacturing equipment by smoothing the stochastic load profile, and reducing the required input power, as well as
- Regulating the line frequency and actively stabilising the grid.

#### *Innovations in the field of energy storage in industrial environments*

The novel outer rotor design maximises the energy content by

- Foregoing the traditional drive shaft and hub,
- Increasing the radii, and
- Maximising the revolutions per minute that a fibre-plastic compounds makes possible.

The flywheel mass is shaped like a hollow cylinder; it has no “dead” mass in its centre, which results in high energy densities. A non-contact, active magnetic bearing in unison with operation under vacuum achieves high power densities and degrees of efficiency while virtually eliminating the need for maintenance. The design (Figure 19) allows for simple scaling to adapt the storage precisely to a particular application and the local conditions. Compared to batteries, a kinetic energy storage is much more durable, which, in turn, reduces investment as well as operating cost.

#### *Functionalities of the kinetic energy storage*

The main feature of the kinetic energy storage of the ETA Factory is the smoothing of the load curves and a reduced peak power demand of the factory – both of which contribute to reducing the system perturbation of the factory and to increase the efficiency on the level of the electric grid. If functionality is considered during the planning of an in-factory micro-grid, power supply transformers can be dimensioned smaller and their efficiency can be increased by permanent utilisation.

An equally important factor is the dynamic grid stabilisation by frequency control. In this context, the efficient factory acts as an active consumer with the energy storage system as an integral part. Thus, conventional power plants have to maintain less reserves and can be operated much more efficiently. In addition, the kinetic energy storage raises the network quality of the micro-grid, and enables island operation in the case of a power grid failure, preventing production downtimes and material damage to the machines. ■

## 4.0 Innovative shell, efficient core

### Authors:

Andreas Maier, Jens Schneider  
ISM+D, TU Darmstadt

In collaboration with:  
Albrecht Gilka Bötzwow  
WiB, TU Darmstadt

Dietz-Joppien Architekten

Anna Scheuermann, OSD

Alexander Wien

Harald Garrecht  
University Stuttgart

### 4.1 The energy optimised building envelope as part of the process chain

Interlinking building and production offers the opportunity to exploit excess thermal energy from the production processes to condition the climate of the building by activating the inner and outer surfaces of the building envelope. These act according to the basic scenarios (cf. chapter 3.1) as large heating and cooling surfaces. In order to reuse or controllably dissipate the waste heat produced by the machinery, special building envelope elements are needed. Therefore, a fine mesh of water pipes is integrated in the wall and roof area which enables a highly dynamic activation.

#### *Structural features of building envelopes made of concrete*

The roof and wall area of the envelope of the ETA Factory is assembled of modular prefabricated concrete parts. Like most industrial buildings, the ETA Factory building is based on a flexible yet homogeneous structure. The regionally available compound material concrete is particularly suited for thermal activation of building parts. Depending on the thickness of the part, it proves as a good heat conductor as well as a high capacity heat storage:

- The thermally activated concrete enables a fast transmission of the radiant heat and,
- In a passive state, its inertial mass in combination with heat insulation guarantees a comfortable indoor climate.

Ultra-high performance  
concrete panels with  
capillary tube mesh

Mineralised foam

Capillary tube mesh

Pi panels made of regular  
concrete

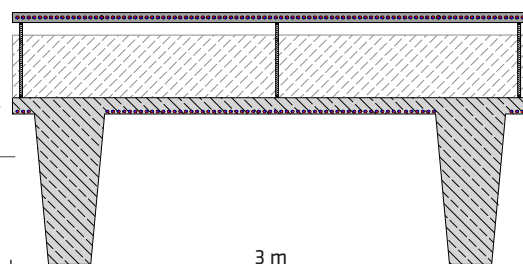

01 Structural design of the thermally activated concrete elements in the roof and wall area





Furthermore, concrete can be shaped freely, and processed easily onsite or at a factory. In contrast to other building materials, it is inflammable, meaning that no other fire protection related structural measures need to be taken. A particularity is the combination with a cementitious (concrete) foam for insulation, a material that has been used for the first time for this purpose at the model factory. This feature allows for an almost non-mixed, mono-material building envelope construction (Figure 01).

The prefabricated concrete building parts of the wall and the roof (Figure 02) are each three metre wide and 10 and 20 metre long, respectively. On the inside face, their shape is that of structurally effective Pi panels. Capillary-like polypropylene tubing is integrated close to the inner surface of the only 12 cm thick, slender elements (Figure 03).

Immediately following the concrete pouring process, the outer surface of the Pi panels was equipped with an insulation layer consisting of ultra-light, mineralised foam (medium heat conductivity 0,06 W/mK). The layers are 30 to 40 cm thick.

One particular challenge was to produce the binding agent necessary for foam stabilisation within the scope of an entirely newly developed semi-continuous process (Figure 04). Since cement hardens when it reacts with water, no autoclaving process is necessary either at the factory or onsite.

02 South-east view of the ETA Factory

03 Position of the capillary-like piping system in the prefabricated reinforced concrete part beneath the outermost reinforcement layer, shortly before pouring the concrete.





04 Manufacturing process of mineralised foam in a semi-continuous process

The outermost layer is composed of very thin (55 mm) yet mechanically highly stress-resistant façade and roof panels made of micro-reinforced, ultra-high performance concrete. These elements combine the functions load-bearing, insulating, enclosing and thermally interacting, thus eliminating a number of interfaces and therewith sources of defect.

*Thermal performance of the building envelope*

The concept of the ETA Factory involves that the building envelope and the production processes interact to eliminate the need for conventional, electricity driven air-conditioning as well as for isolated cooling of the components resulting from energy-intensive production processes.

In order to achieve this, the according building-relevant process must take place quickly. Conventional concrete core activation cannot fulfil this requirement because it uses the thermal storage mass of the building parts, which entails a phase-delayed process. It is exactly here, where the near-surface activation of the building envelope elements in combination with very low material thickness comes into play: this working principle allows for high thermal reactivity of the building parts as well as for a virtually

05 Element temperature development over time at a given supply temperature of the capillary tube mesh

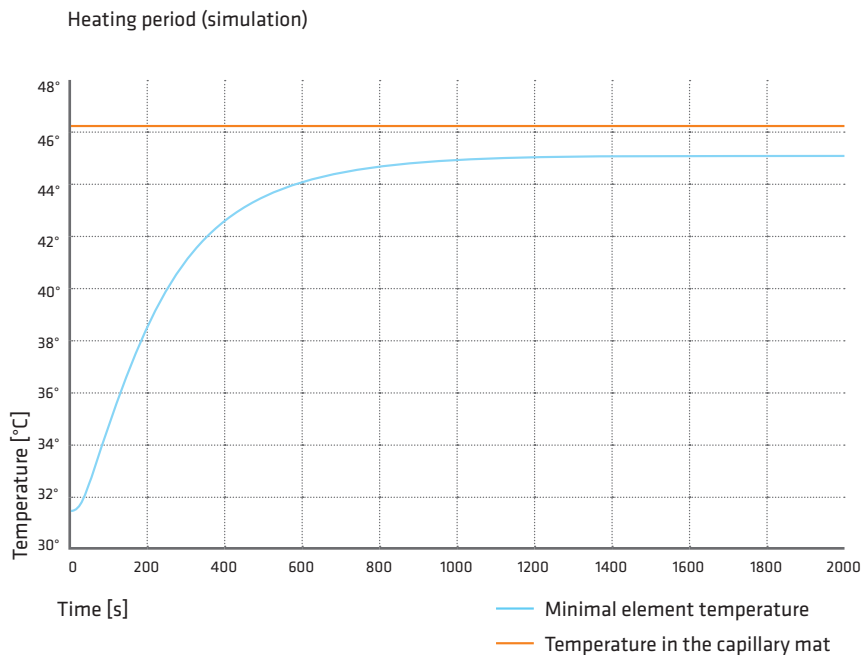

uniform temperature distribution across the cross-sections of the exterior building envelope. It is possible, for example, to evenly raise the temperature within the cross-section of the façade from 30 °C to 45 °C in around 20 minutes (Figure 05). The flow rate of the water-glycol mix inside the capillary-like tubing system is 0.5 m/s.

In spite of fast activation processes, the in-transient heat output in the roof and wall planes runs up to 75 to 95 W/m<sup>2</sup> (Figures 06, 07). Cooling output reaches 92 to 62 W/m<sup>2</sup>, whereby the difference between the return-line temperature and the supply temperature is only 2 K. It is imperative that a structural analysis must take into account the loading conditions that result from the temperature-induced loads of the building part activation. Based on the structural concept, the temperature differences caused only little restraint but relative deformation between the building parts. These movements are accommodated by the dedicatedly constructed connections and joints.



06

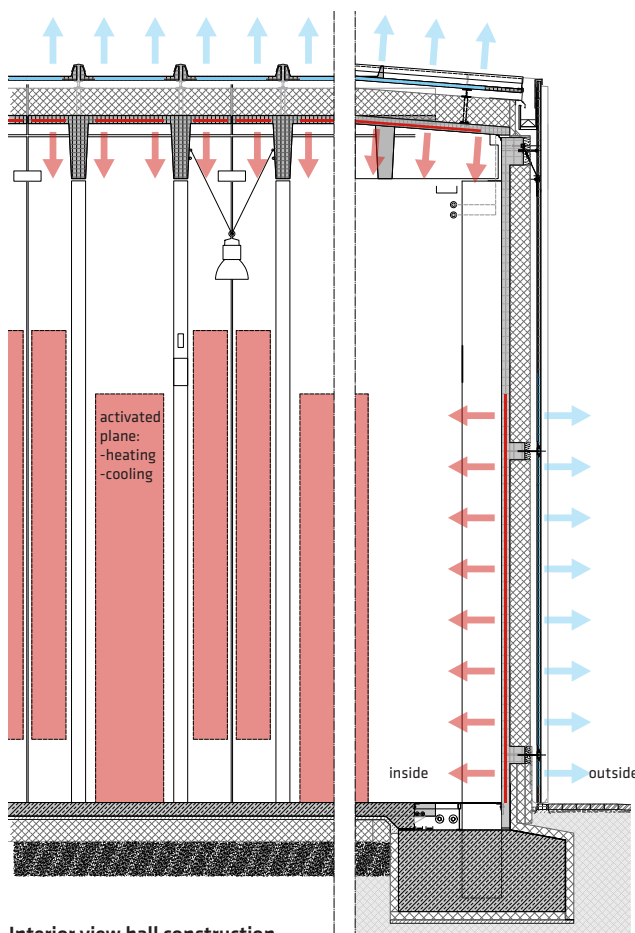

**Interior view hall construction**  
made of load-bearing prefabricated steel-reinforced concrete parts with integrated capillary tube mesh and mineral foam insulation

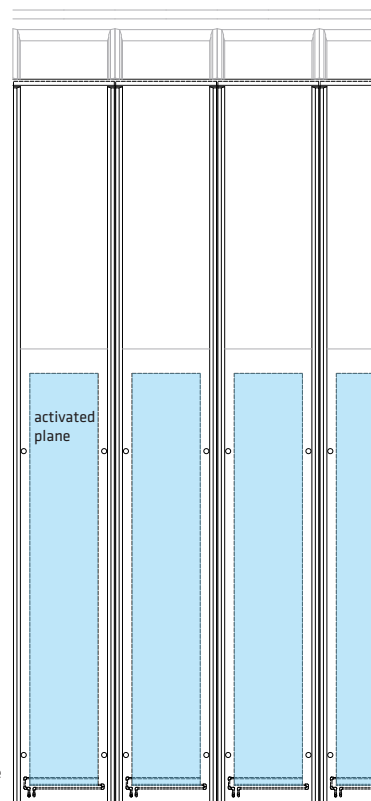

07

**Exterior façade 'Ducon' with integrated capillary tube mesh for heat output (summer); prefabricated curtain-wall façade made of micro-reinforced, ultra-high performance concrete**

06 Façade panels made of micro-reinforced, ultra-high performance concrete (mrUHPC)

07 The two details show the thermally activated wall and roof elements

08 System components of the flat slab system with integrated air duct network

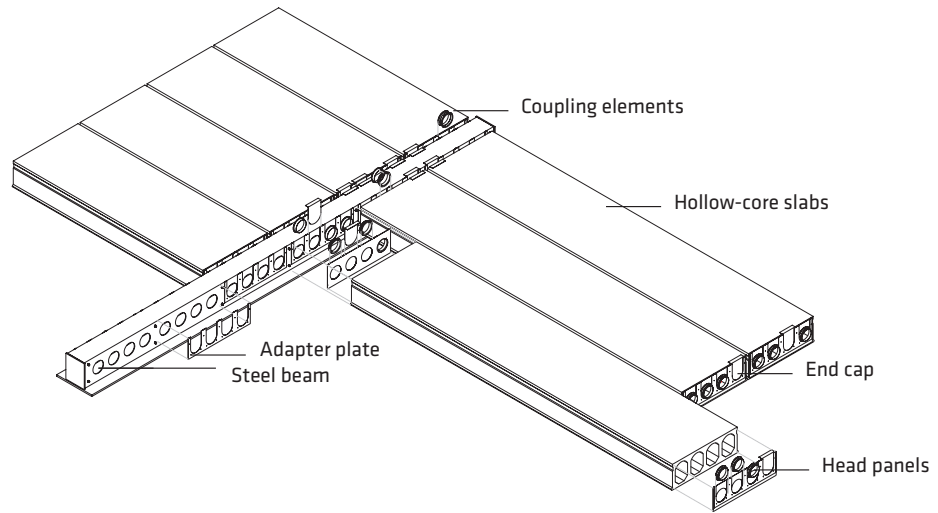

#### 4.2 Energetic integration of ventilation ceilings and glass façades into the ETA Factory

Energetic efficiency can be improved by either achieving a higher degree of utilisation while maintaining the same energy expenditure, or reducing the energy demand while maintaining the same production results. The ETA Factory follows both approaches: on the one hand by incorporating glass façades with integrated lamellae for daylight direction, and on the other by exploiting structurally optimised hollow-core slabs that serve as a ventilation duct system.

##### *Integrated ventilation ceiling made of hollow-core concrete parts*

Mechanical ventilation of insulated rooms is usually realised with an air duct network, which is mounted underneath the room ceilings and therefore take up a lot of space. Using the hollow core of prefabricated slabs made of prestressed concrete in combination with air-ducting hollow steel profiles means creating a functionally synergetic building part, with the added benefit that the tempered supply air thermally activates the thermal storage mass of the concrete slab.

In the production building, the seminar room intended for regular and advanced learning courses is supplied with fresh air via drill holes on the underside of the hollow-core panels through connections between the steel edge beams and the hollow sections of the flat slab (Figure 08).

The multiple use of existing building parts creates economic advantages over conventional building methods if it means less construction finishing work, lower storey heights and shorter building construction periods. In the ETA Factory, the air duct network is fully integrated into the ceiling construction; the load-bearing structure and the ventilation system become one single unit, and elaborate installations beneath the load-bearing slabs can be omitted (Figure 09).

The special building code requirements regarding fire protection for air-ducting, load-bearing building parts are fulfilled with special air outlets that close autonomously in case of fire.

09 Different ventilation systems beneath flat slabs

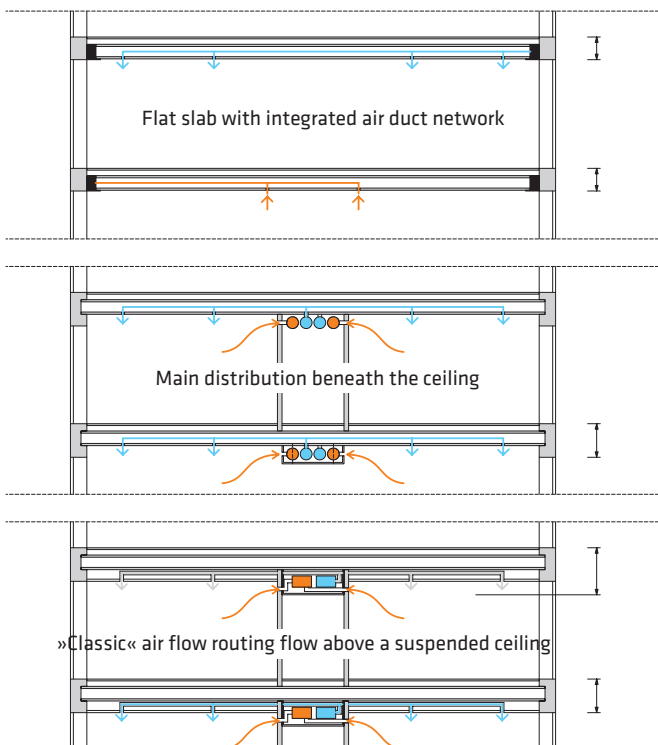

*Daylight directing with glass façades*

The lighting concept of the ETA Factory is designed to exploit incoming daylight as optimally as possible, thereby reducing the demand for artificial lighting to the absolute necessary minimum. This is accomplished with a combination of daylight dependent, controllable and dimmable LED lights in the production hall, and direction-selective lamellae in the cavity of the insulation glazing of the south façade. The latter also reduce the incidence of long-wave solar radiation. The radiation would add to the negative effect of the waste heat from the machinery on the indoor climate, and would cause temperature-induced deformation of the production machines and their power units. The lamellae direct the sunlight toward the ceiling, and thereby – depending on the position of the sun – far into the building.

A particularly prominent feature are the parametrically protruding façade elements in the lower third of the south façade (Abb.10) on both sides of the gate with the delivery zone. These slanted, screen printed glass panes are glued in and contrast the otherwise flush glazing.



10 The south-facing element façade with light-directing lamellae in the gap between the insulating glass panes of the double glazing units (above) and the parametric façade elements (below)

11 Segmented element façade with integrated gate system





12

12 North-facing façade with transparent fixed glazing and opaque, projected top-hung windows with vacuum insulation

13 Interior view of the seminar room with a ventilation ceiling made of hollow-core prestressed concrete slabs



13

The location specific inclination of the panes is adapted to the course of the sun along the north-south oriented building. The triangular panes on the sides and the upper trapezoid pane provide sun protection. The lower trapezoid pane, on the other hand, is fully transparent, thus allowing views of the research area and the surrounding campus (Figure 11).

The joints and connections of the two gable façades are structurally adapted to the boundary conditions of the thermally activated roof and longitudinal façade. At the glazed east and west façades, a translucent capillary system integrated into the space between the insulating glass panes provides for smooth, diffuse light scatter into the building.

The north façade, enveloping the office spaces, is a post-and-beam construction with a structural glazing look. To optimise the heat insulation of the façade, fleece-covered vacuum insulated panels are arranged inside the space of the insulating glass panes of the opaque, openable elements. The  $U_g$  value of these elements is only  $0.23 \text{ W}/(\text{m}^2\text{K})$ . For comparison: the transparent double glazing has a  $U_g$  value of  $1.1 \text{ W}/(\text{m}^2\text{K})$  (Figure 12).



14

14 Southern view of the ETA Factory with its distinctive, parametric glass elements and the delivery zone.

15 The ETA Factory is accessed from the north, the entrance area leads to the office area.



15

### 4.3 Design

The ETA Factory follows a holistic planning approach with a synergetic consideration of the subsystems machine, building services and building. The design approach for the industrial building conceptualised within the scope of this project develops the design, function, construction and building envelope from the inside outward. Human and machine define the requirements posed on the energy efficient factory of the future – not the other way around.

#### *Design and function of the building*

The model factory presents itself prominently at the entrance to Campus Lichtwiese in immediate vicinity of the already existing combined heat and power station, which is also dedicated to the topic “energy”. The linear building is oriented in a north-southerly direction and is 40 m long and 20 m wide (Figure 18).

The building is accessed from the north – opening up toward the three-storey office area with seminar and meeting rooms as well as utility rooms in the basement. The southern, approximately 550 m<sup>2</sup> part of the building is taken up by the 11 m high hall, respectively production area (Figure 16, 17).

On the long side, the thermally activated, massive cladding structure envelopes the

45

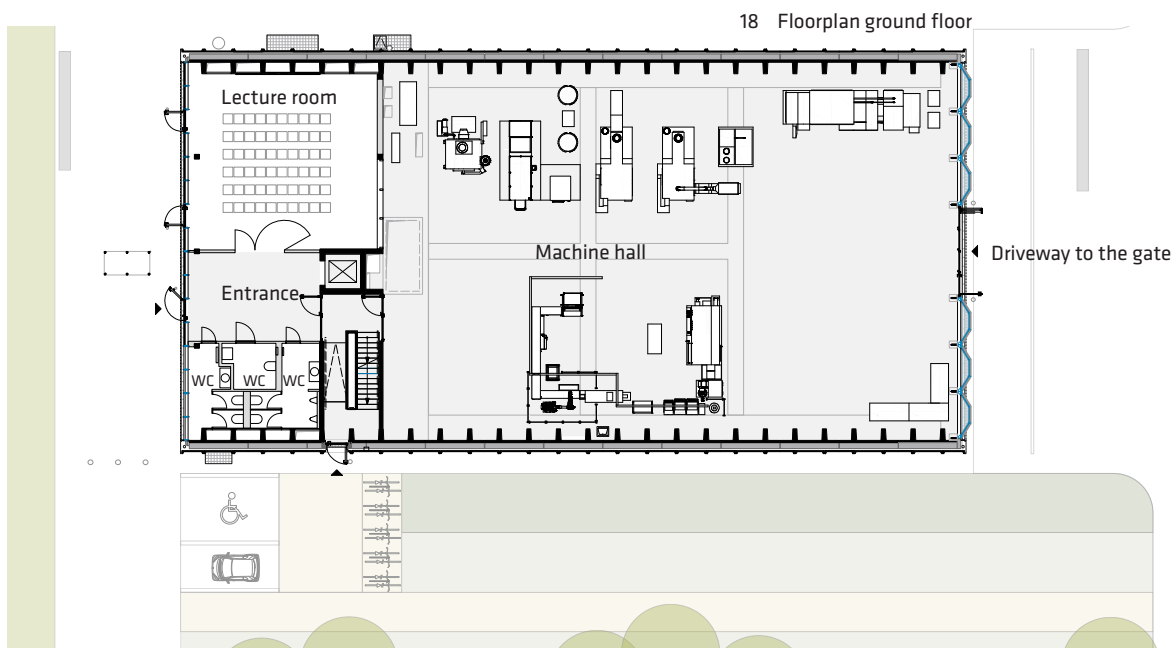
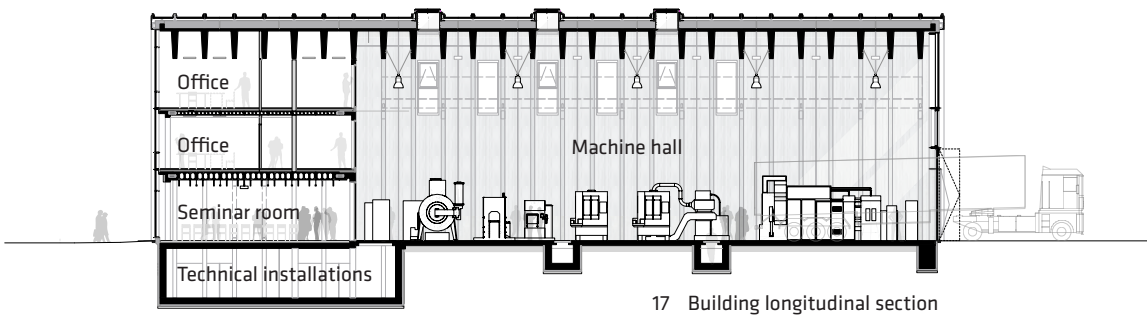
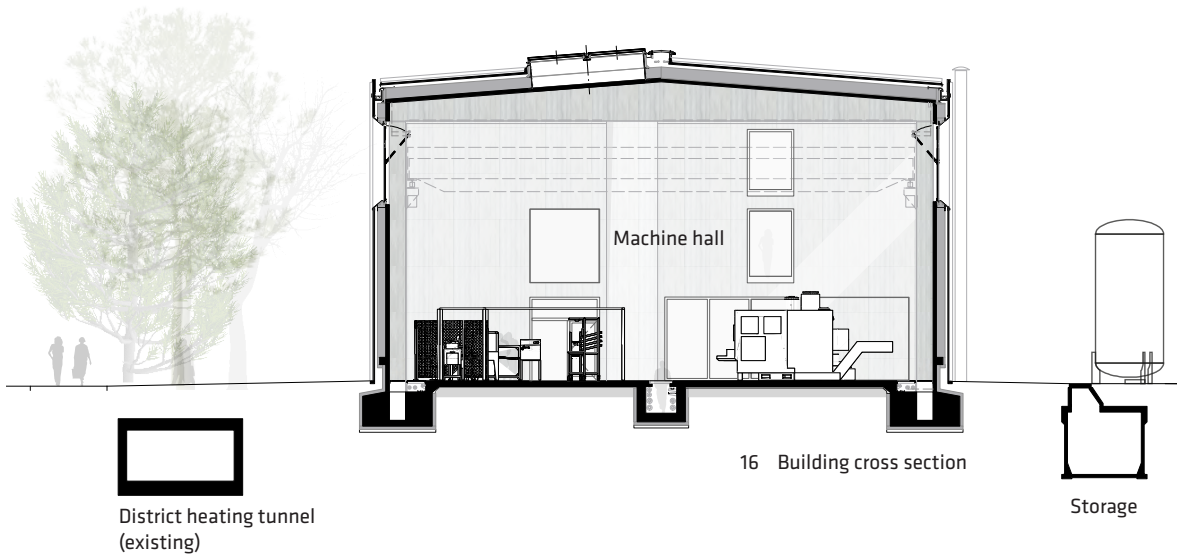





19



20

structure. The homogeneously designed, prefabricated steel reinforced concrete elements reach from the wall across the roof. On the north and south face sides, the fully glazed façades form the boundaries of the plain cubature. They offer transparency with interesting inside and outside views.

Only one of the four energy storages is located above ground in front of the building – the external high temperature level vacuum storage sits in front of the east façade. The other three low and medium temperature storages are invisible below ground (Figure 16). A sprinkler system installed on the roof supports the heat dissipation via the building envelope. It is fed from a rain water reservoir at the north-westerly corner of the building.

19 Rendering with a view of the north façade, vision at the beginning of the project ...

20 ... and the factual result viewed from the same angle at the time of the opening.

21 A simple and functional building, whose south façade is coined by the parametric glass elements.



	Mineralised foam	EPS	XPS
$\lambda$ [W/(mK)]	0.06	0.035	0.035
$d_{\text{eff}}$ [m]	0.250	0.146	0.146
GWP [kg CO <sub>2</sub> -Eqv./m <sup>2</sup> insulating material]	31.23	6.84	8.68
PE <sub>e</sub> [MJ/m <sup>2</sup> insulating material]	15.19	3.60	3.11
PE <sub>ne</sub> [MJ/m <sup>2</sup> insulating material]	90.40	196.88	263.96
PE <sub>ges</sub> [MJ/m <sup>2</sup> insulating material]	105.59	200.48	267.06

22 Comparison mineralised foam with EPS. The recycling potential of the foam concrete is not yet taken into account.

The construction concept also includes the deconstruction aspect, which is solved well since the entire construction is almost exclusively built with cementitious materials. The individual layers are easy to separate, and the material can be recycled due to its mineral composition. The life-cycle assessment of the novel foam concrete has significant advantages over conventional, organic insulation materials. Mineral foam with an overall thickness of 25 cm, for example, features a primary energy demand of 106 MJ / m<sup>2</sup>. XPS, on the other hand, requires 267 MJ / m<sup>2</sup> from raw materials production to installation at the construction site while providing a comparable insulating effect (Figure 22).

23 South-west corner with thermally activated concrete shell and transparent element façade





24

*Planning in the tension field of mechanical engineers and constructors*

Innovation often arises at the interface between different expert disciplines. Without the willingness to work together on an interdisciplinary level between mechanical engineers, civil engineers and architects, such complex tasks can never be dealt with successfully. Even if energy and resource efficiency within an overall system of machines, the novel, energetically activatable building structure and envelope, and the thermal and electric energy storages stand in the foreground, many small details contribute to the work place quality and communication of a factory. This is an aspect that all experts and engineers need to keep in mind.

The innovations, which were realised in a rather short time period, were only possible because the entire research and planning team, consisting of participants from the building sector, the industry, sponsors as well as builders and contractors, worked together in a transparent and open minded manner. If we want to master the challenges that the future will bring, we need to keep blurring the boundaries between the individual disciplines. ■

24 The eleven metre high machine hall with thermally activated concrete elements in the wall and roof sections.

25 The materials glass and concrete dominate the appearance of the office area.



25

## 5.0 The virtual, energy efficient factory

Next to the practice-oriented research on the “physical object”, the digital model of the ETA Factory is equally important for the work on the project since it serves as the basic element. The “virtual energy efficient factory” bundles together all essential findings and enables a knowledge transfer to similar problem statements. Computer-aided simulation is a tool that, in unison with continuously rising performance levels of hardware and software systems, plays an increasingly important role.

It allows for analyses of complex dynamic systems without the need for direct physical interference. Thus, control strategies, system configurations and system processes can be virtually worked out and tested without risk and immediate impact on the physical system.

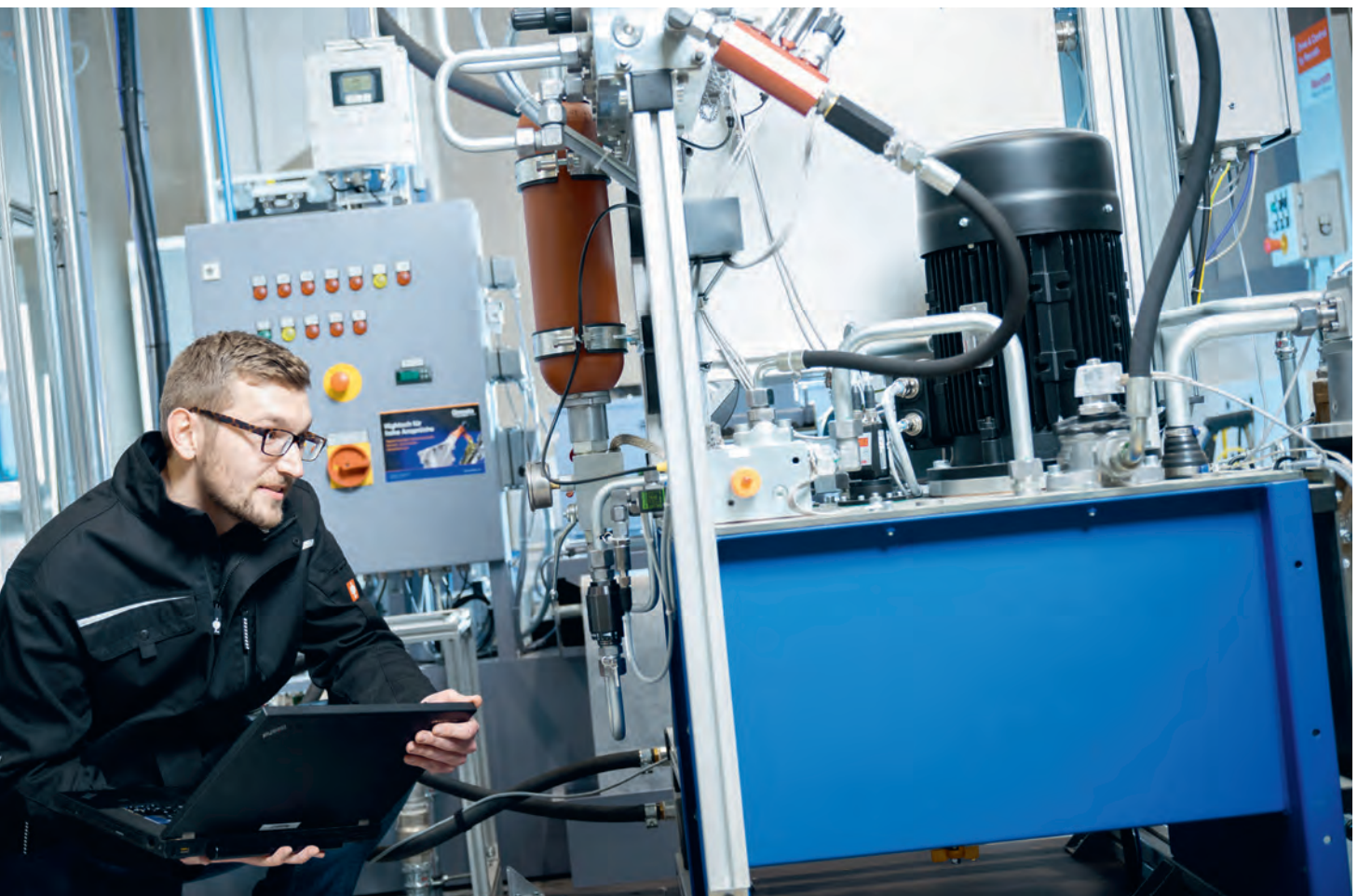

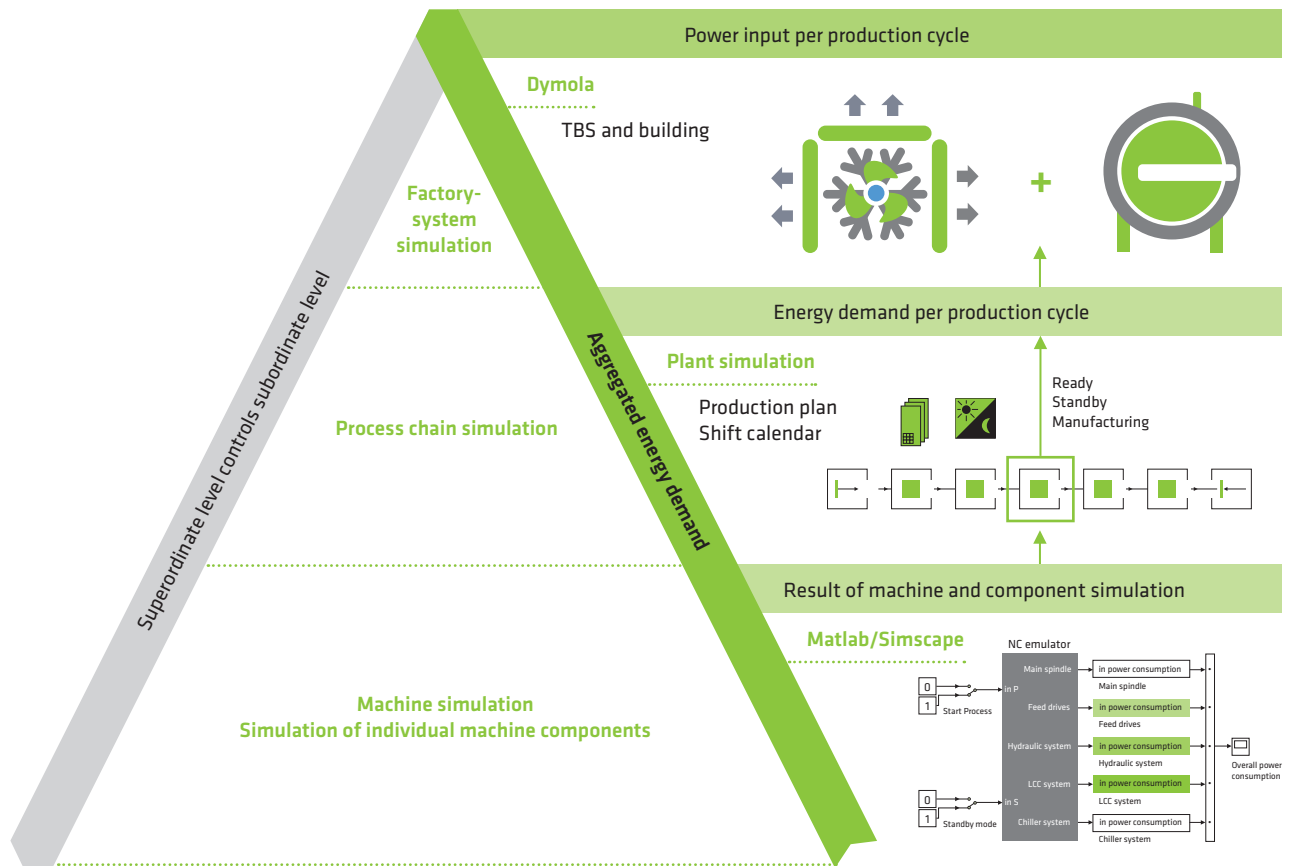

02 Simulative representation from component to factory system

5.1 Information gain with simulation

Studies and research projects prove significant, economically viable and technically realisable energy efficiency potential in the German industry, most of which, however, has not yet been put to practice. Possible reasons for this perpetual “lack of energy efficiency” are rooted in market failure and organisational deficiencies. But often, the only thing missing is an evaluation of the economic potential. In a nutshell, companies are frequently unable to quantify the potential cost savings resulting from energy efficiency measures, and to identify possible implications, or they shy away from related identification work. This means that there are no standardised tools to provide companies with the necessary transparency to close the energy efficiency gap based on well-founded data. One tool can be a simulation-based evaluation of the energy demand of energetic systems (machines, technical building services and buildings). Particularly during the planning phase, during which information is in great demand but unavailable as far as actual measured data is concerned, simulation can provide critical pointers for concept identification.

Authors:

Dominik Flum, Philipp Schraml  
 PTW, TU Darmstadt  
 Andreas Maier  
 ISM+D, TU Darmstadt

### 5.2 From component to factory system

In the course of the research project, the team succeeded in developing simulation solutions and simulation tools for the relevant target groups. Various simulation environments were used to fulfil particular requirements.

#### *Machines and process chain*

Detailed insight into the operating behaviour of the machines and their components is needed to be able to analyse possible energy efficiency optimisation. To achieve this insight, continuous simulation models were generated with the software program MATLAB / SIMULINK. From an energetic point of view, the models allowed us to identify optimum machine configurations and component dimensioning.

Since the production process chain in the ETA Factory is a so-called discrete parts manufacturing process (production of individual, countable items), it was self-evident to reproduce this in a discrete simulation environment. A simulation environment that is well established in the automotive industry is PLANT SIMULATION. By integrating the results of the machine simulations, the state-dependent energy demand of the machines can be incorporated into the production planning processes. Therefore, the user in manufacturing companies do no longer need “special software programmes” that have to be purchased for the purpose (Figure 02).

#### *Thermal-hydraulic system interaction*

In order to represent the production infrastructure, which, in the ETA Factory is primarily focussed on thermal crosslinking, the project partners mapped the thermal-hydraulic system of the ETA Factory in DYMOLA: it comprises the production machines, the technical building services (TBS) and the thermally interacting building structure.

The centre of the building model is an aerodynamic model of the hall to simulate the thermal conditions of the production hall (Figure 03). The models of the building structure are linked to this model. The building model with the machine and TBS models forms the overall model of the ETA Factory. The necessary thermal boundary conditions are parametrised from real-time weather data.

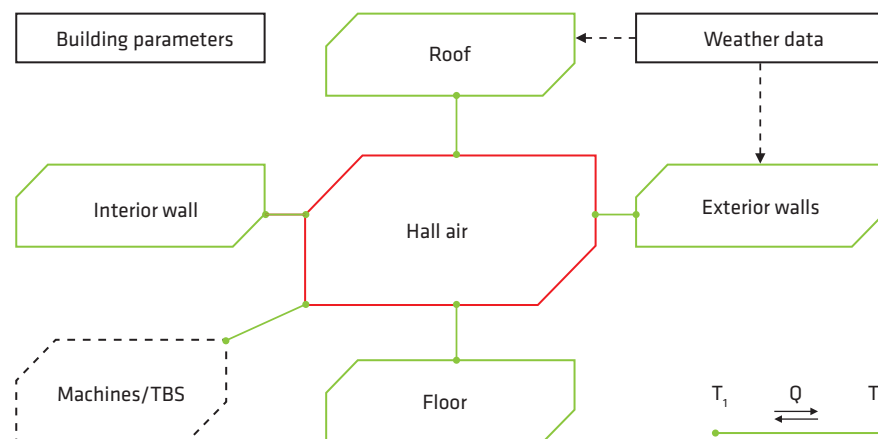

03 Building model - schematic representation

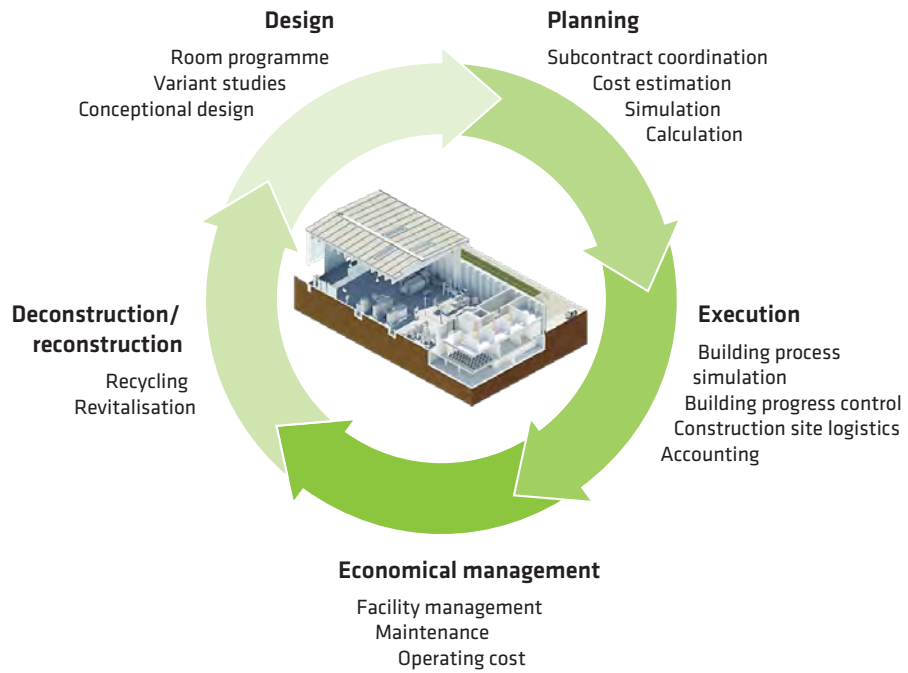

On the one hand, the overall model can be used to plan operating strategies for existing systems. On the other hand, it can be employed to verify layout aspects for the transfer to future cases of applications in simulation tests, without compromising the safety of the real system.

04 Possible partial processes, shown in a BIM model

*Data management of the building infrastructure*

Usually, classic 2D or 3D planning of buildings is done with



virtual architectural models, whose information content does not significantly exceed that of the objects contained later in the construction plan.

Instead, database-driven models such as Building Information Modelling (BIM) can contain all information relevant for planning, operation as well as deconstruction of the building (Figure 04).

This data includes graphic, geometric as well as alphanumeric parameters, but also mass, properties and characteristic values of building parts and installations. This means that BIM can take into consideration the classic tasks of architectural models, the lack of definition in the design process for variant studies, the execution of approval and execution planning with the main details and rendered presentation models. Thus, the tool offers an added value for builder-owner, site manager and subcontractors during the planning and building process – but especially for the facility manager, as well, later during the operating process. This offers the possibility, during planning, execution and during the use phase, to identify target conflicts at an early stage, and therewith to optimise the economic efficiency of all steps.

*From partial to integral simulation – an outlook*

The Factory Life Cycle Design and Management shall provide a platform for the life cycle-oriented design and operation of factories. It makes it possible to analyse the energy consumption of factory systems with a networked simulation environment in a holistic manner (Figure 06).

06 Principle of overall simulation environment

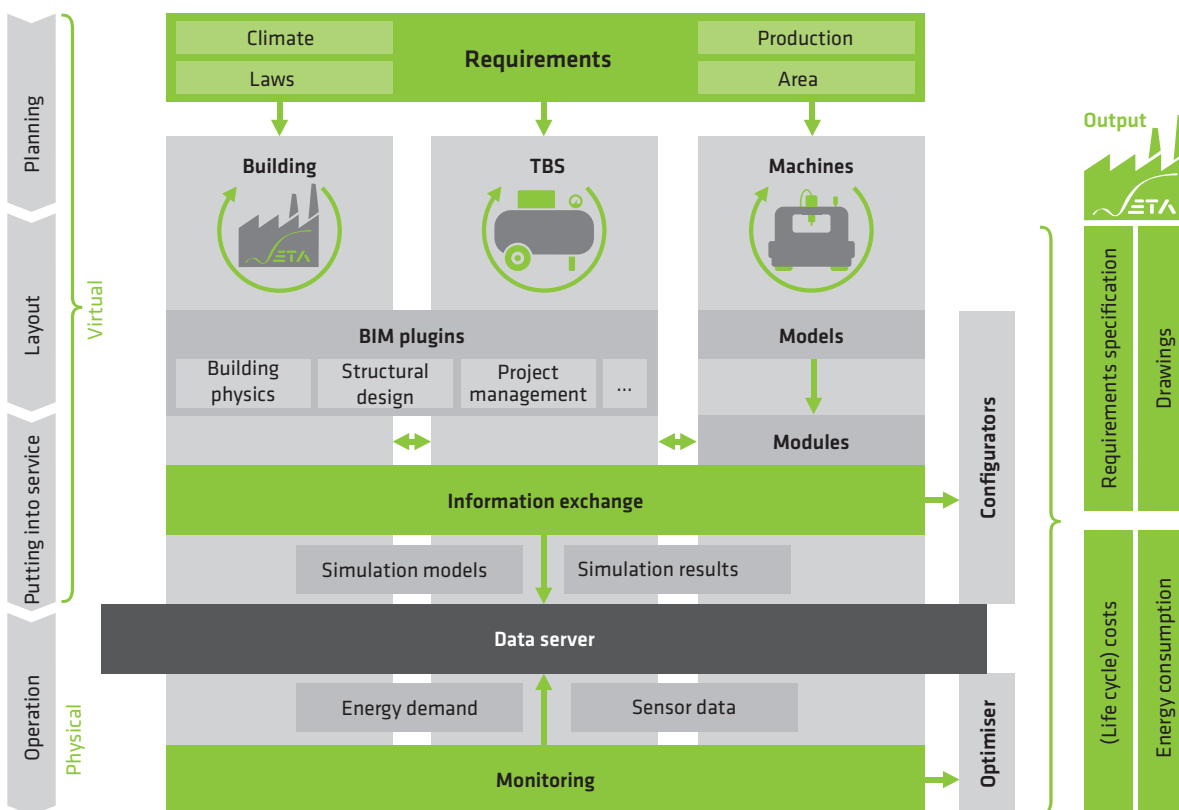



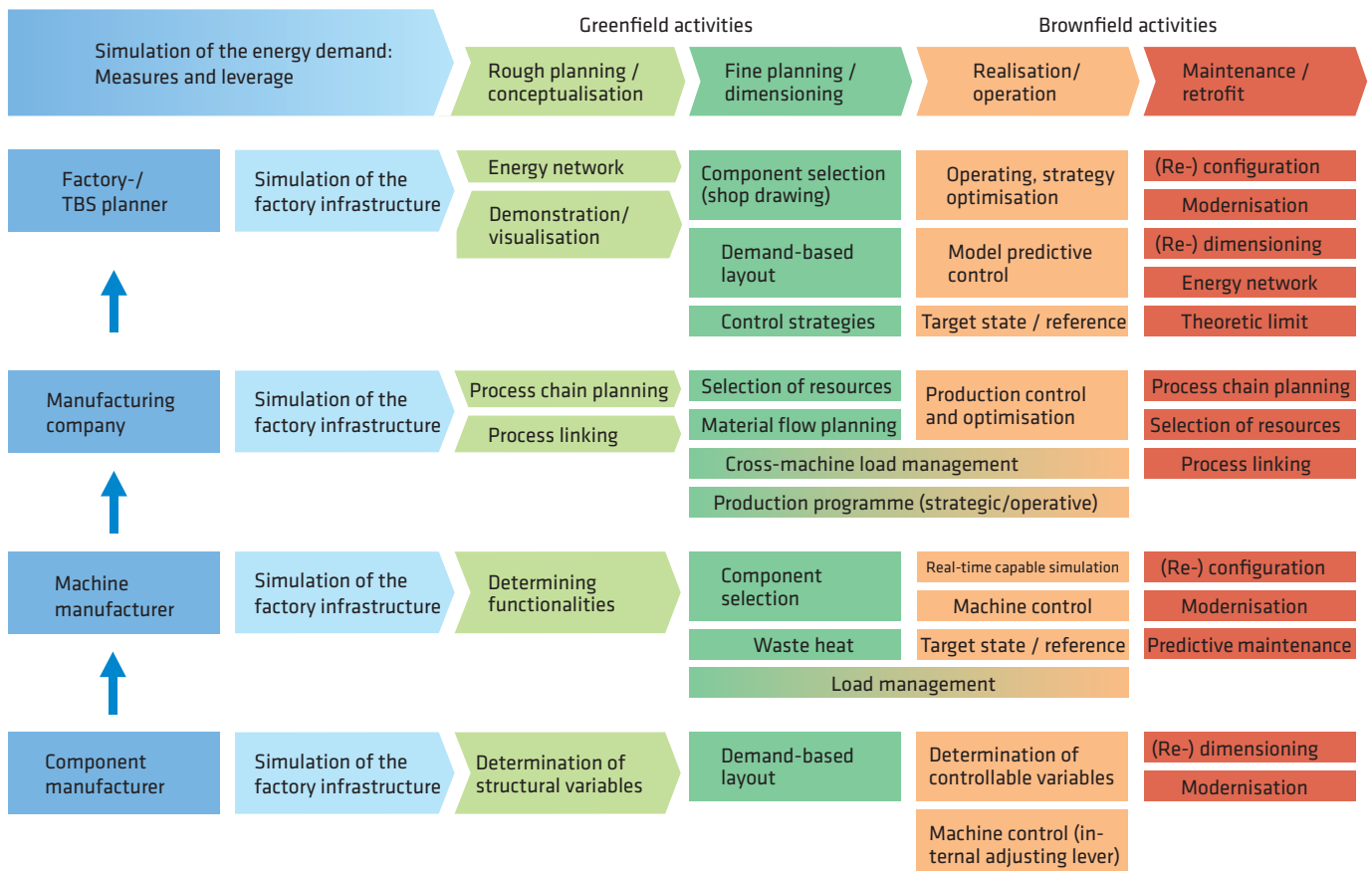

07 Application failures in the factory simulation

Building up here upon, a virtual MSR system is to be established that generates simulation models based on real-time data, thus laying the foundation for the realisation of self-optimised and parametrically optimised factory and production control. At the same time, the accrued, energy-related data is stored in a data base to serve as a knowledge base for future planning and layout decisions. This allows to control the complexity going along with the modularisation of the factory, which, in turn, can lead to a reduction of the transaction cost for efficiency measures in the industry. ■

**Innovations of the virtual ETA Factory**

- Establishing customised layout and dimensioning tools for those participating in the factory planning process;
- Feasibility of simulation tests to plan optimum operating strategies and to increase the economic efficiency of individual measures;
- Demonstrating cross-system impact on the total energy consumption of the factory (electric and thermic).







# ETA Forum

## Theory and practice under one roof

The key activities research, education and continuing education as well as realisation are merged under the umbrella of the ETA forum. In addition to long-term transfer of scientific know-how into the industry, the focus lies on the networking with (regional) companies.

**Research** – In the ETA Factory, scientific personnel conduct research in the areas energy efficiency and energy flexibility. Their work is supported by the work of demonstrators, which are used to illustrate and test the researched issues. Our staff regularly presents their results at international conferences; the exchange with other experts during these events keeps them sensitised for the most current research topics of today and tomorrow.

**Education and continuing education** – True to the motto “learning by doing”, interested parties from the industry and business can take part in our workshops to experience “energy efficiency, hands-on” and to learn to identify potential. All of our courses are closely linked to our teaching factory: tours, practice-oriented exercises and the incorporation of technology

demonstrators provide for application-oriented knowledge transfer. And we take good care of our young academics: we already offer students a lecture on energy efficiency and flexibility as well as on other topics related to energy in the production environment. Furthermore, we offer an extra-occupational, continuing academic education programme.

**Realisation** – Interested companies can make use of our energy-related services in the form of onsite analyses. Within this framework, we can provide customer-specific evaluations of efficiency measures, and we can accompany according realisation processes, if so desired.

At the ETA forum, we maintain research and study groups and small bilateral projects to ensure ongoing, mutual exchange and the best conditions for mutual research activities. We face current challenges around the topics energy efficiency and flexibility in the manufacturing environment in a cooperative manner, and develop solutions. The basis for these activities is a close-knit, daily collaboration between our scientists and our partner companies.

Further information is available upon request. ■

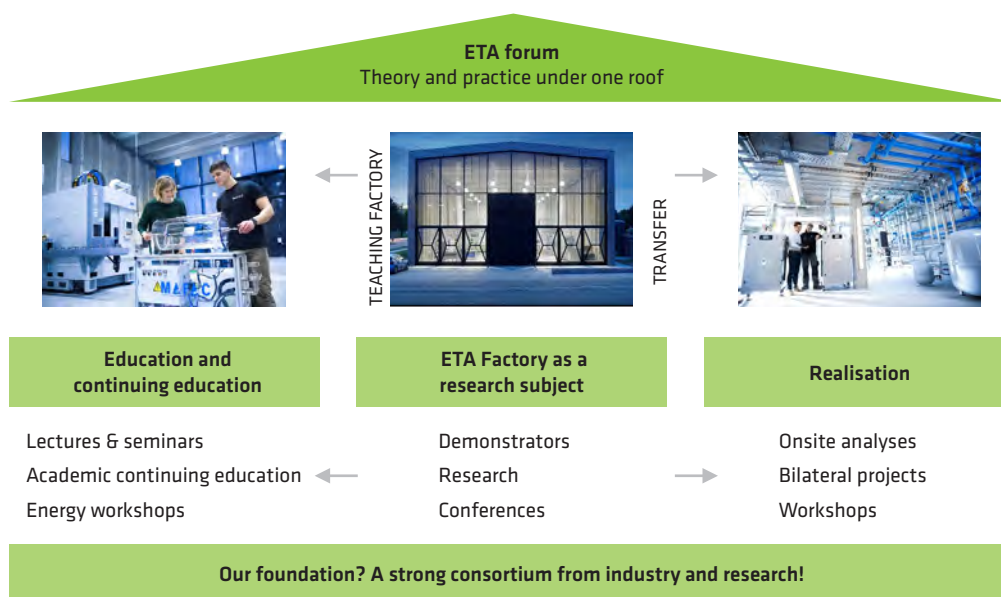

# Factsheet (1)

## Results for the industry

Three operation scenarios were contrasted to determine how effective the measures taken in the ETA Factory really are. Common to all scenarios are the particular period of use and degree of utilisation of the production machines. The result shows that the measures developed in the project offer a total of **45 percent savings in primary energy. This corresponds to 247,700 kWh and 130,500 kg CO<sub>2</sub> per year.**

By accomplishing many realised projects and testing propositions of different research topics, the ETA Factory has established itself as an exclusive research environment. But in equal measure, our explicit objective is that the

successful results are factually applied in manufacturing companies. To comply with this objective in an exemplary manner, part of the manufacturing processes of our research partner Bosch Rexroth was analysed at their Elchingen facility.

The efficiency-related solutions developed at the ETA Factory can save approximately **1,325,000 kWh** primary energy, calculated across the entire system inventory. This means an average electricity savings potential of 24 percent per system. Furthermore, a savings potential of approximately **900,000 kWh** lies in hiding related to heat recovery measures.

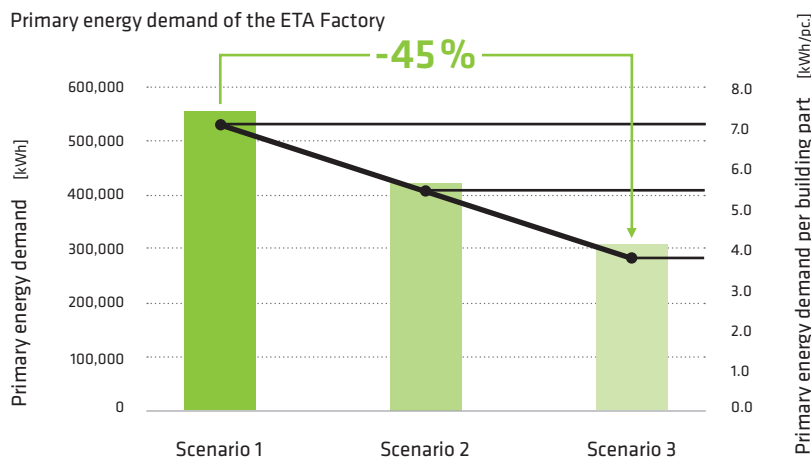

### Assumptions

- 17 manufacturing shifts per week/8 h production
- Utilised capacity of the production systems machine tools 70 %, cleaning system 40 %, heat treatment furnace 80 %
- Primary energy factors electricity 1.8; natural gas 1.1

Comparison of the primary energy demand per building part of the individual production machines in the ETA Factory (Scenario 1 = 100 %)

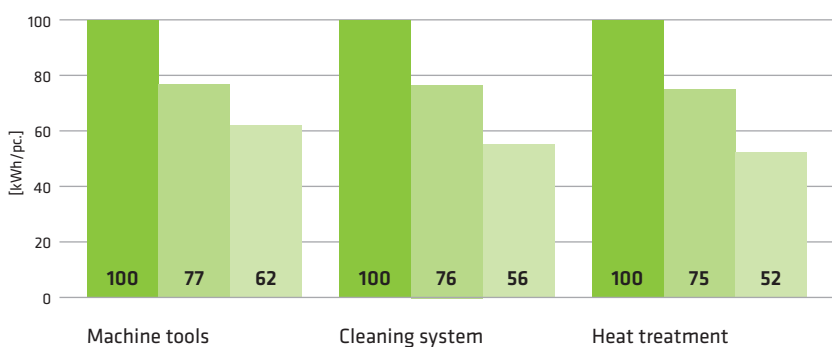

### Scenario 1

- Standard machines
- Cold generation with compression cooling
- Heat production from electric energy

### Scenario 2

- Energy efficiency measures implemented
- Heating of the heat treatment with natural gas recuperator burner

### Scenario 3

- Thermal crosslinking of furnace and cleaning system
- Cooling the furnace and machine tools with the building envelope



# Factsheet (2)

## Energy efficiency measures for the industry

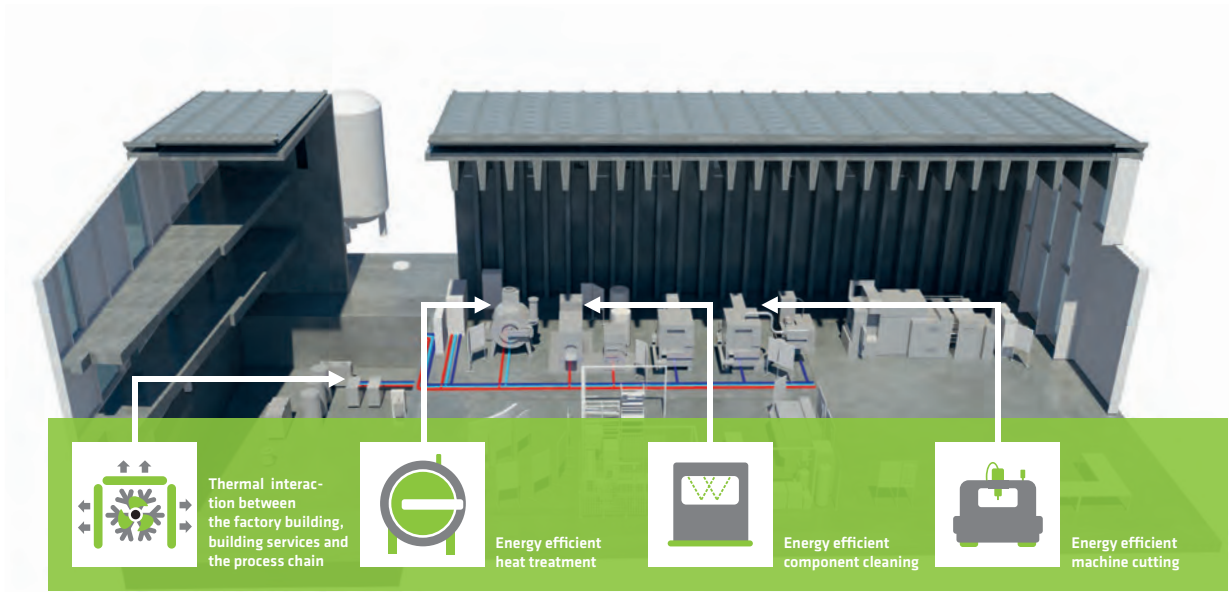

The ETA Factory with the production chain in a sectional model. Efforts were made and measures developed and realised to increase the energy efficiency in the areas of machine cutting, component cleaning and heat treatment. The measures are allocated to the three operating scenarios. In addition, other energy optimisation measures were developed («alternative technologies»), which, as substitution measures, were not considered in the scenario analysis and must therefore be separately identified.



Thermal interaction between factory building, building services and process chain	
Measure	Savings potential in the scope of the ETA Factory Operating scenario 3
Implementation of heat transformation technologies	
Implementation of electrically operated heat pumps to network machine tools and cleaning system	Potential in the ETA Factory: 38 %
Implementation of absorption chillers to cool the machine tools and the building with waste heat from the curing ovens	The operation of the absorption chillers requires only the electric power of the pumps and the control of the system. At the ETA Factory this comes to a total of max. 1 kW. Add to this the pumps of the oven, machine tools, floor cooling as well as the KaRoMas, that total 4 kW max.
Additional use of the absorption chiller to heat the building	
Implementation of VSI stratified storages as high temperature energy storage	
Utilisation of VSI stratified charge storages to store waste heat collected from heat treatment	Enables optimum re-use of waste heat from heat treatment, for example to heat the cleaning system
Methods to dimension thermal-hydraulic networks	
Utilisation of a simulation model of the thermal networks of the ETA Factory to quantify the savings potential of different networking technologies in other factories	Enables an assessment of different energy savings measures
Decision making methodology for the use of thermal industry technology	Enables a systematic recoding of energy savings potential by thermal crosslinking of matching heat sources and sinks





Energy efficiency heat treatment		
Measure	Savings potential in the scope of the ETA Factory	Operating scenario
Media-efficient heat treatment		Scenario 1
Optimised process control with nitriding potential values	> 10 % nitriding gas	Alternative technology
Pulsed process gas supply	40 % nitriding gas	Alternative technology
Energy efficient machine technologies		
Reducing heat loss	> 10 % fuel gas	Scenario 2
Recuperator gas burner	15 % fuel gas	Scenario 2
Efficiency optimised aggregates - control of the combustion air blower - reduced revolution speed of the cooling blower	20 % electric energy of the combustion air blower approximately 50 % electric energy of the cooling blower (process impact needs to be considered)	Scenario 2
Exhaust heat recovery of the process gas burner	15 %	Scenario 3
Optimised exhaust gas burning	> 20 % fuel gas	Alternative technology
Serial connection of the cooling circuits	Exergy increase by 6 kW	Scenario 3



Energy efficient component cleaning		
Measure	Savings potential in the scope of the ETA Factory	Operating scenario
Application of energy efficient cleaning process	> 65 %	Scenario 1
Optimisation of cleaning additives	up to 50 %	Alternative technology
Concept for a machine tool integrated pre-cleaning with laser cleaning process	42 %	Alternative technology
Energy efficient machine technologies		
Reducing heat loss and efficiency optimised aggregates	> 28 %	Scenario 2
Exhaust heat recovery with heat pump	> 25 %	Scenario 2
Development of a heat exchange module	38 %	Scenario 3



Energy efficient machine cutting		
Measure	Savings potential in the scope of the ETA Factory	Operating scenario
Energy efficient machine technologies		
Use of variable-speed hydraulic pumps	> 50 %	Scenario 2
On-demand cooling lubricant supply with speed-controlled rotary pump	21 %	Scenario 2
Use of on-demand cooling	51 % (machine cooler) 84 % (electrical cabinet cooler)	Alternative technology
Use of energy and resource efficient drive system alternatives	Losses decreased by 40 % Efficiency increased by 5 %	Alternative technology
Exhaust heat recovery		
Machine cooling without compression chiller with heat exchange module	approximately 10 – 25 % of the energy demand on the machine level; centralised generation was offset	Scenario 3
On-demand cooling of the cooling lubricant by pulsing the cooling lubricant system circulation pump	> 50% in process	Scenario 3

# Key data of the ETA Factory

## Financing

Funded by the Federal Ministry for Economic Affairs and Energy  
Overseen by Projektträger Jülich  
Supported by the Federal State of Hessen  
Financed with third-party funds from the industry as well as own funds of Technische Universität Darmstadt and the institutes PTW and ISM+D

## Project coordination

**Overall project:** Technische Universität Darmstadt, Department of Mechanical Engineering  
Institute of Production Management, Technology and Machine Tools  
Lead: Prof. Dr.-Ing. Eberhard Abele  
Project lead: Dipl.-Wirtsch.-Ing. Martin Beck

**Building construction:** Technische Universität Darmstadt Department of Civil and Environmental Engineering | Institute of Structural Mechanics and Design  
Lead: Prof. Dr.-Ing. Jens Schneider  
Project lead: Dipl.-Ing. Andreas Maier

## Research institutes

TU Darmstadt | Department of Mechanical Engineering  
Institute of Production Management, Technology and Machine Tools  
Lead: Prof. Dr.-Ing. Eberhard Abele

TU Darmstadt | Department of Mechanical Engineering  
Mechatronic Systems in Mechanical Engineering  
Lead: Prof. Dr.-Ing. Stephan Rinderknecht

TU Darmstadt | Department of Civil and Environmental Engineering  
Institute of Structural Mechanics and Design, LPh 1-3 Structural Analysis, LPh 1-8 façade planning  
Lead: Prof. Dr.-Ing. Jens Schneider

TU Darmstadt | Department of Architecture  
FG Entwerfen und Baugestaltung, LPh 1-3 Architecture  
Lead: Prof. Dipl.-Ing. Johann Eisele and Dr.-Ing. Frank Lang

University of Stuttgart | Department of Civil and Environmental Engineering  
Institute of Construction Materials  
Lead: Prof. Dr.-Ing. Harald Garrecht

TU Darmstadt | Department of Civil and Environmental Engineering  
Institute of Construction and Building Materials  
Project lead: Dr.-Ing. Albrecht Gilka-Bötzow

## Construction site signboard

Project idea: 01/2011  
Project start: 05/2013  
Start of construction: 09/2014  
Completion: 03/2016

**Builder-owner:** TU Darmstadt, Dezernat V, Department of Building and Property Management

**Lead:** Dipl.-Ing. Edgar Dingeldein

**Project lead:** Dipl.-Ing. Georg Rombusch

**Location:** TU Darmstadt, Campus Lichtwiese

## Building parameters:

Usable floor space 960 m<sup>2</sup>  
GFA / GRV 1,450 m<sup>2</sup> / 10,000 m<sup>3</sup>  
Length 40 m  
Width 20 m  
Height 11 m

## Planning

### Architecture

Dietz Joppien Architekten AG, Frankfurt/M. Potsdam, LPh 3-9 Concept planning, approval planning and building permission application, tendering, construction supervision

**Lead:** Prof. Dipl.-Ing. M.Arch. Anett-Maud Joppien,  
Dipl.-Ing. M.Arch. Albert Dietz | Project lead: Dipl.-Ing. Joachim Stephan

### Technical building services

Kruse Ingenieurgesellschaft mbH&Co.KG Heizung, Lüftung, Klima, Sanitär, Elektro | Lead: Dipl.-Ing. Ronald Kruse | Project lead: Lindrun Winkler  
Wien Architekten Hypokaustendecke | Lead: Dipl.-Ing. Alexander Wien

### Load-bearing structure, thermal insulation

osd office for structural design | Lead: Prof. Dr.-Ing. Harald Kloft  
Project lead: Dr.-Ing. Frank Brückner

### Free space

Sommerlad Haase Kuhli  
Lead: Raimund Haase | Project lead: Daniel Müller

## Project partner Innovations

### Production/machines

Bosch Rexroth AG

### Control technology, drive technology, hydraulics

Clean Lasersysteme GmbH, Laser cleaning systems

EMAG GmbH & Co. KG, Machine tools, manufacturing systems

MAFAC E. Schwarz GmbH & Co. KG, Aqueous component cleaning systems

GTW GmbH, Mechatronic systems on antifriction bearing technology, spindle units

IVA Industrieöfen GmbH, Industrial furnaces, complete systems

IWT Bremen, Foundation Institute of Materials Science, Materials engineering, process engineering, surface technology

ZAE Bayern e. V., Applied energy research

### Building

Ducon GmbH & Co.KG, bidding consortium Röser Ingenieurbeton/  
Traub GmbH & Co.KG | Prefabricated parts of façade and roof construction

Franz Oberndorfer GmbH & Co KG, Hollow-core slabs

Schüco International KG, Parametric façade

Okalux, Vacuum insulation panels, light-directing lamellae, light-scattering inlay for insulation glass

Dow Corning, Structural glazing silicon

## Machine configuration

**Machine tools:** EMAG VLC 100 Y (vertical turning lathe),  
EMAG VLC 100 GT (vertical turning lathe), MAG XS 211 (machining centre)

**Cleaning system:** Mafac Java (2-bath aqueous cleaning), Mafac Kea (1-bath aqueous cleaning), Cleanlaser CL-50 (laser cleaning)

**Furnace:** IVA RH 655 (gas nitriding furnace)

## Building services configuration

**Heat production:** Viessmann Vitobloc EM 6/15 and EM 9/20 Viessmann Vitodens 200-W

**Cold generation:** Viessmann Vitocal 350, Scherdel absorption chiller

**Thermal storage:** Viessmann Vitocell 2x1 m<sup>3</sup> Hummelsberger VSI 6 m<sup>3</sup>  
Finger Beton HVFA 2x13 m<sup>3</sup>/1x25 m<sup>3</sup>

**Compressed air:** Atlas Copco VSD22+

**Pump technology:** Grundfos (mainly Magna 3)

**Lighting:** Luxstream

**EV charging station:** TU Darmstadt | Institute for Electrical Power Supply with Integration of Renewable Energies

### Electric vehicle

Opel Ampera

Project partners:



We thank our sponsors BMWi and the State of Hessen as well as TU Darmstadt for their financial and administrative support, and all project participants, planning firms and companies for the content-related collaboration within the framework of the research project ETA Factory. The findings resulting from this project form the basis of this brochure.

Contacts:

Technische Universität (TU) Darmstadt  
 Institute of Production Management,  
 Technology and Machine Tools (PTW)  
 Eugen-Kogon-Str. 4  
 64287 Darmstadt, Germany

Tel.: +49 6151 / 16 200 80  
 Mail: [info@ptw.tu-darmstadt.de](mailto:info@ptw.tu-darmstadt.de)  
 URL: [www.eta-fabrik.de](http://www.eta-fabrik.de)

Technische Universität (TU) Darmstadt  
 Institute for Structural Mechanics and Design  
 (ISM+D)  
 Franziska-Braun-Straße 3  
 64287 Darmstadt, Germany

Tel.: +49 6151 / 16 230 13  
 Mail: [mailbox@ismd.tu-darmstadt.de](mailto:mailbox@ismd.tu-darmstadt.de)  
 URL: [www.ismd.tu-darmstadt.de](http://www.ismd.tu-darmstadt.de)



## ETA – Energy efficiency, Technology and Application centre

The ETA Factory stands for research and development of innovative technologies that improve the efficiency of industrial production processes and aim at linking the energy systems within a factory. Hereby, energy networking is not limited to machines and components but also refers to the building and the interaction with its envelope. This approach requires cross-disciplinary collaboration between the engineering disciplines responsible for building the factory on one

hand and the factory operation on the other. It is our shared vision to advance energy efficiency by thinking ahead and by sharing the results of our research with the expert public. For scientists and students, the ETA Factory represents a large research device, which, as a national showcase project, demonstrates how energy-efficient concepts, technologies and developments can be translated into practicable applications.